

# PROPAGATION OF MINNOWS and other bait species

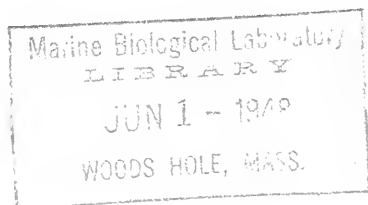

CIRCULAR 12

UNITED STATES DEPARTMENT OF THE INTERIOR

FISH AND WILDLIFE SERVICE

## FOREWORD

At the second annual meeting of the Tri-State Fishery Conference in 1946, a special committee was appointed to assemble existing information on bait culture and to assign specific research to each agency for that season. This bulletin presents the results of the work to date.

The following men associated with the committee members have done much of the actual work of assembling and compiling the data. John Dobie of the Minnesota Fisheries Research unit was given the task of organizing the original manuscript and of fitting into it the results of current experiments conducted by the contributing agencies. He also incorporated portions of a Minnesota report written by Janus Ridley and has compiled experimental data from published literature. O. Lloyd Meehean, Chief, Division of Game-fish and Hatcheries, U. S. Fish and Wildlife Service, prepared the section on pond construction. George Washburn of the Michigan Institute for Fisheries Research contributed much to the revision of the original outline based on his early experience as a minnow dealer and his more recent experimental work in minnow culture, especially with suckers and creek chubs. Elmer Herman of the Wisconsin Conservation Department made available his findings on the feeding of minnows in holding tanks. Raymond Johnson of the Fisheries Research unit wrote the identification section and edited the manuscript.

### Tri-State Minnow Committee

George Sprecher, Chairman

D. John O'Donnell

Wisconsin Conservation Department

Norman Moe

R. E. Johnson

Minnesota Conservation Department

Fred A. Westerman

Albert S. Hazzard

Michigan Department of Conservation

O. Lloyd Meehean

C. F. Culler

Fish and Wildlife Service

# PROPAGATION OF MINNOWS and other bait species

By J. R. Dobie, O. L. Meehean, and G. N. Washburn



## CIRCULAR 12

Fish and Wildlife Service, Albert M. Day, *Director*  
United States Department of the Interior, J. A. Krug, *Secretary*

UNITED STATES GOVERNMENT PRINTING OFFICE : 1948

For sale by the Superintendent of Documents, Washington 25, D. C. - - - - Price 35 cents



## CONTENTS

	Page
Foreword -----	i
Introduction -----	1
Propagation of bait species -----	2
The minnow pond -----	3
Selection of species -----	24
Operation of the minnow pond -----	25
Special considerations in the propagation of suckers -----	41
Disease and parasite control -----	53
Control of predation -----	60
Handling of minnows and operation of holding tanks ----	63
Causes of loss -----	63
Reduction of loss -----	64
Source of materials and equipment -----	76
Earthworms, crayfish, and crickets -----	76
Earthworms -----	76
Crayfish -----	78
Crickets -----	79
Leeches and insect larvae -----	80
Leeches -----	80
May fly nymph or wigglers -----	81
Hellgrammites -----	82
Caddis fly larvae -----	83
European corn borer -----	84
Catalpa worm -----	84
White grubs -----	85
Goldenrod gall worms -----	85
Wood borers -----	86
Life histories of important bait fishes -----	86
Northern creek chub -----	91
Northern pearl dace -----	92
Horny-headed chub -----	93
River chub -----	94
Western black-nosed dace -----	95
Fine-scaled dace -----	96
Northern red-bellied dace -----	96
Southern red-bellied dace -----	98
Western golden shiner -----	98
Lake emerald shiner -----	100
Northern common shiner -----	101
Spotfin shiner -----	102
Brassy minnow -----	103
Fat-headed minnow -----	103
Blunt-nosed minnow -----	105
Central stone-roller -----	106
Common sucker -----	107
Northern black bullhead -----	109
Stone catfish -----	110
Western mud minnow -----	110
Bibliography -----	112



# PROPAGATION OF MINNOWS AND OTHER BAIT SPECIES

BY J. R. Dobie, O. L. Meehan, and G. N. Washburn

## INTRODUCTION

With a shortage of minnows in public waters now a reality and strict legislative regulations on minnow seining looming in the near future, the bait dealer is faced with the necessity of rearing his supply of bait fishes in ponds or other private waters. Most dealers will find the change from free-lance seining to the propagation of minnows in ponds difficult. This bulletin is a summary of available information on bait culture and is intended as a guide for those interested in raising minnows and other bait species as a commercial venture.

The growing number of fishermen appearing each year in the northern States has resulted in a greater fishing load and an increased demand for suitable bait minnows. In an effort to satisfy the demand, commercial minnow dealers have seined lakes and streams over wide areas and have trucked their perishable commodity over great distances. Dealers, fish-culturists, sportsmen, and biologists fear that the supply of bait fishes is being depleted and that this drain on the natural food of game fishes is a serious problem.

Several variable factors determine whether collecting of this kind is a wasteful or a profitable undertaking. Seasonal fluctuations in the availability of bait fishes are the rule; they are not found in the same pools or over the same shoals in our lakes and streams at all times. These changes in the supply of minnows are matched by inverse fluctuations in demand: there are fewer anglers fishing during spring and fall when minnows are plentiful, and a great demand exists during the warm summer months when the supply is limited. Only a few minnow dealers have constructed outdoor ponds or indoor tanks large enough to hold many thousands of fish from the time of their greatest availability to the months of greatest demand.

The natural geographic distribution of several commercially important minnow species sometimes does not coincide with regions where they are most in demand,

and expensive trips must be made over great distances for collecting purposes. The lake emerald shiner, so abundant along the shores of the Great Lakes at certain seasons, is a highly prized bait minnow, but it does not hold or transport well during summer months. High losses are sustained on long trips to inland areas, and the cost to the dealer and to the angler is high.

Environmental factors in northern Michigan, Wisconsin, and Minnesota may also restrict the supply of minnows in an area where demand for minnows is often great. Cooler, more sterile waters in that region do not support the needed quantities or species of bait fishes, making necessary the transfer of large numbers of minnows from southern areas at great expense.

The rearing of bait minnows is by no means easy, but the advantages are many. The cost of raising fish may be less than the cost of seining in distant waters, and the dealer can have a supply on hand at all times to meet demands. The angler will be supplied with bait in better condition, and the natural food for game fish in public waters will be preserved.

## PROPAGATION OF BAIT SPECIES

Fish have been propagated in artificial ponds in Asia and Europe for many centuries. Carp, a species of minnow, have been produced abroad at a rate of several thousand pounds per acre of water and have been produced in ponds in the United States at a rate of more than 200,000 carp per acre. Careful management of ponds may enable the fish-culturist to produce even more than this number. The raising of minnows is not a simple procedure of stocking a pond and reaping a harvest some months later. A dealer should not undertake an extensive program of raising minnows until he has acquired a knowledge of the basic requirements of minnow culture.

Before the bait dealer starts a program of minnow propagation, he should give detailed consideration to the location and construction of the pond, the selection of the species of fish to be stocked, the fertilization of the pond, and the methods and seasons for harvesting the fish. The location and construction of the pond are the most important of these factors because all other considerations are based on the characteristics of the pond.



## The minnow pond

Ponds for the production of minnows may be divided into two categories: single ponds, such as those which utilize run-off from surrounding land, and a series of ponds supplied by a much larger source of water and maintained for large-scale production of minnows. There will, of course, be differences in design for each job, depending upon local conditions, so that only general recommendations on construction can be made. Wherever possible, the services of an engineer or of someone experienced in the construction of fish ponds should be employed in order to make the best possible use of the water supply, particularly if the construction job involves a large investment.

Regardless of size, location, or the number of ponds built, there are four essential requirements for success in operating ponds:

- a. The water supply must be dependable at all seasons of the year and of sufficient amount to exceed all requirements.
- b. The pond should be constructed on soil that will hold water.
- c. Where a series of ponds is built, construction should, if at all possible, be such that each pond can be handled independently of the others.
- d. Ponds should be constructed in such a way that they can be drained completely, emptied of fish, and refilled when necessary.

### WATER SUPPLY

A suitable and adequate water supply is of primary importance and should be considered first in selecting a site for rearing ponds. To be suitable, the water should be only moderately hard and should contain no other species of fish; the temperature of the water should be high enough to promote rapid growth (p.47); the pH or hydrogen-ion content should be slightly on the alkaline side.

Springs and artesian wells are most desirable because such water comes from a dependable source of supply, is easily controlled, permanently clear, and generally free from pollution. A spring should be protected from contamination by surface water, which may cause the supply to become turbid or polluted by drainage from stables, yard ponds, and like sources.

Hard water may be undesirable because it generally contains obnoxious gases such as carbon dioxide, nitrogen, hydrogen sulfide, and marsh gas. All of these are injurious to fish by actually poisoning or asphyxiating them. Other waters may contain excessive quantities of iron. In nearly all of these instances, the water can be purified and made suitable for fish by running it over a series of falls or baffles and by storage in a reservoir with a large surface area to permit thorough aeration. Spring and artesian water should be tested beforehand by placing fish in it. A temporary pond or trough may be employed for the purpose. If possible, the fish should be held in the pond or trough for a whole season in order to obtain a good test; however, a shorter period, perhaps a month, may be sufficient. If the fish remain alive, the water can be considered suitable.

Permanent construction should include a reservoir at the spring itself. This reservoir may be of concrete or riprapped with stone or brick for protection. A way must be provided so that excess water from the supply can be diverted around the pond or ponds. A sufficient flow should be provided to compensate for seepage and evaporation from the ponds during the propagation season.

Natural water supplies, such as creeks, lakes, rivers, or ponds, may be utilized as a source of water but should be considered only when springs or artesian supplies are not available, or where the natural sources have all the necessary attributes of a good water supply. These sources are subject to change in volume, temperature, and turbidity and may be polluted. In addition, they generally contain undesirable species of fish which may prey on minnows and reduce production of the pond. No hatchery operator has successfully screened undesirable fishes from ponds except by the use of expensive and elaborate gravel filters.

In selecting a stream to provide water for rearing ponds, one should take into consideration primarily the fluctuations in volume and the amount of turbidity. Turbidity is particularly important because excessive silt may gradually fill the ponds to which the water is supplied. Turbid water also reduces productivity by restricting light penetration and, as a consequence, the development of food organisms. Where the turbidity is periodic and of short duration, the water can be by-passed downstream.

The volume of water must be kept within certain limits throughout the year, this volume to depend upon

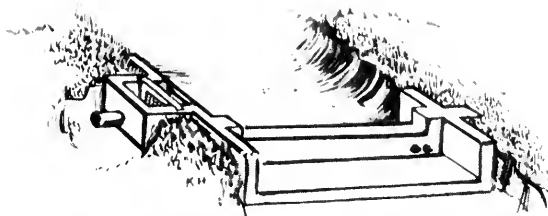

Figure 1.—A low dam with outlet for supplying water to ponds.

the number of ponds operated from the source of supply. Fortunately, by building proper structures, a suitable volume of water can be obtained. If the stream flow is constant or if the fluctuation in volume is within narrow limits, sufficient water may be obtained by the building of a low dam.

This dam should be located so that water can be obtained for the ponds by gravity flow. The structure should be of concrete, equipped at one side with an intake box from which the desired amount of water may be obtained for the pond system. Dams of low design provide no obstacle to flood waters and allow debris to pass over readily without obstructing flow. Where the flow is intermittent or becomes considerably reduced during the dry season, it may be necessary to make a larger impoundment by constructing a higher dam (fig. 1).

The dam should be anchored in both banks of the stream with bulkheads as high as the banks—this, to protect the banks. The spillway should be built somewhat lower than the bulkheads. A concrete apron should be provided to keep the water flowing over the spillway from undercutting the dam. The intake box should be provided with a coarse grating to obstruct large masses of debris, and it should have a slot in which a fine screen is inserted to keep out leaves and materials that might obstruct the flow of water through the pipe to the pond, and to keep out other fishes. So that the screen may be kept clear of debris without too much difficulty, the screening surface should be large in proportion to the amount of water used.

Where there is considerable debris in the water, the operator may have difficulty in keeping the screens clean. In this situation, another type of construction is often used. This involves building a concrete box in the bottom of the stream; the box is slightly raised from the bottom so that it does not become covered with gravel and so that the current continually washes over the surface and carries away leaves and other debris.

Information concerning a structure designed along these lines is obtainable from a qualified civil engineer.

Where water cannot be obtained by gravity, pumping is sometimes justified. The pumping cost is a continuing and constant one, and operations must be on a scale large enough to justify it. It is essential to have a cheap source of power. In order to make operations as thrifty as possible, the ponds must be tight enough to prevent too great a loss from seepage. Some operators arrange construction in such a way that when one pond is being drained, a portion of the water can be directed into another empty pond and used again. This saves pumping costs and fertilizer.

Where a series of ponds is operated, the most satisfactory results are obtained by storing the water in a reservoir from which it may be taken as required. Generally, such a reservoir is constructed by building an earthen dike just below the source of water. This has the advantage of providing an adequate source of water supply as needed and eliminating obnoxious gases or minerals which are removed by aeration and storage.

Water may be forced to a higher level by means of a ram if conditions are satisfactory for its operation. When the source of water is a spring, it must have a large capacity to justify the use of a ram, as a ram is wasteful. Only about one-seventh of the water can be forced up grade. A 1-foot fall from the spring to the ram is required for every 10 feet that the water must be forced vertically to the pond, and the flow is further reduced in proportion to the horizontal distance the water must be pushed. A large reservoir which will permit the use of water in the pond system, as necessary, is preferable to having the ram supply the ponds. Usually, obtaining water for fish ponds by the use of a ram is inadequate and unsatisfactory.

A windmill can be used for small ponds of  $1/4$  to  $1/2$  acre. Local conditions, such as the amount of rainfall and evaporation, will help to determine the size of pond that can be filled and maintained by this method. The size of the pumping equipment and other elements involved in windmill operation will assist in deciding whether a windmill should be used. It may be suitable for a small natural pond.

#### LOCATION OF THE PONDS

Enough emphasis cannot be placed upon the proper location of ponds. The selection of a good site results

in economical construction and satisfactory operation. Time spent in surveying possible sites before a final selection has been made will pay dividends. Many failures are traceable to a compromise in design features because of the cost difficulties involved. Selection of a site on which favorable local conditions can be utilized will preclude excessive expenditures and impractical installations.

After a suitable water supply has been located, other details of site selection may be considered. The area must be relatively flat and large enough to include all the ponds, buildings, and other structures required for a modern hatchery. The ground should slope gently from the upper end, which is slightly below the source of water, to the lower end, where water is drained from the individual ponds into a convenient watercourse. The main objective is to select a site of suitable size for anticipated need and where topography is such that ponds can be constructed without moving or hauling too far an excessive amount of dirt. Any good engineer can make a topographic survey to determine the feasibility of constructing a pond system on a piece of land.

The most satisfactory ponds are constructed on impervious soil. Clay soils or soils with a high clay content are most desirable. The best material consists of approximately two-thirds sand and gravel and one-third clay, but generally some compromise in quality has to be made. It is good practice to have the soil tested. If there is any doubt as to the porosity of the structure, borings should be made to determine the depth of the impervious layer. Care should be taken that there are no rock strata reaching the surface or beds of gravel anywhere in the pond bottom. Water follows these formations readily with considerable loss to the pond.

Where an extensive pond system is not desired, small impoundments for the propagation of minnows may be located in an area much more restricted than a hatchery-pond system would require. These ponds may be located in a natural gully where the land slopes from three directions into the pond area and where the dam will be neither so long nor so high that the cost of construction will be excessive. The shape of such a pond depends entirely upon the topography.

It is not desirable under any circumstances to dam a stream to make a pond or locate the pond where it is subject to regular floods. The best impoundments are supplied by just sufficient spring water to maintain

the pond level or are located high enough on the drainage basin so that the level is maintained by run-off from surrounding land.

In sections of the country where rainfall is relatively high, as in the Gulf States as far west as Louisiana, the drainage area should be about 5 acres for each acre-foot of water in the pond. In those sections where rainfall is lower—this includes southeastern Wisconsin, and southern, central, and western Minnesota—the proportion of drainage area should be greater. It is particularly desirable that drainage be from good pasture land, a stable forest area, or other well-covered land. Eroded or improperly tilled soils allow rapid run-off, which results in silty waters and gradual filling of the pond. Some operators who must take waters from tilled land, construct a small settling pond or silt basin above the regular pond. The lower end of the pond site should be of sufficient width to provide an adequate auxiliary spillway to carry off occasional flood waters.

#### Pond Construction

Small impoundments are generally constructed by building a dam across a narrow gully where the banks are of sufficient height to provide water deep enough for fish during the winter. The depth at the dam should be from 5 to 15 feet, depending upon the severity of winter weather and the topography of the pond bottom. In northern Illinois the depth should be at least 10 feet; the farther north the pond, the more this figure should be increased.

First consideration is given to laying out the dam and outlining the confines of the water level in the pond. Because of the acreages of water impounded, earthen dams are used almost exclusively. Determination of a desirable top width is the first step in the design of the dam. Generally, the top of the dam is 6 or 7 feet wide; but if it is to be used as a road for automobile travel, the dam should be at least 11 feet wide. The equipment to be used in constructing the dam may also affect the width of the top. If teams are used, the top of the dam should be 5 feet wide; tractors require a width of at least 10 feet. When the height of the dam and width of the top are known, the base can be laid out.

Ordinarily, the upstream or pond side of the dam is sloped at the rate of 3 feet for each 1 foot of

height. On the downstream side the slope is generally, 2 to 1. However, if the soil contains more than the recommended amount of sand or gravel, the slope should be increased to as much as 5 to 1, depending upon the nature of the construction materials used. This simply means that if the top is 7 feet wide and the height is 10 feet, the base will be 57 feet wide.

The site of the crest of the dam should be laid out first, then stakes set along the inside and outside toe or limits of the dam. Stakes should also indicate the limits of the water level in the pond. The dam should be high enough to allow 2 to 3 feet of freeboard; that is, the top should be 2 or 3 feet above the normal water-level of the pond (fig. 2).

The first step is to cut down all trees and bushes. These should be removed from the site or stacked and burned. All stumps should be removed from the pond site, particularly if the pond is to be drained for the removal of minnows, in which case it is also desirable to grade the bottom so that no low spots or pockets will be left after the pond has been drained. Every piece of wood or stump should be removed from the site where the dam is to be located. If this is not done, it may cause trouble when the wood decays.

The next step in construction of the dam is to form a tight bond between the dam and the base upon which it rests. If the surface is covered with a layer of organic matter, this should be removed and stored for later use in covering sections of the dam which will be seeded with vegetation. The area covered by the base of the dam should then be plowed.

No structure is better than its foundation. To assure a good pond, a section should be removed from the middle, parallel to and directly under what will be the highest portion of the dam, down to solid-clay soil. If clay soils are underlaid with sand or gravel, do not dig through the clay into the sand, as this will cause the pond to leak. Excavation for the clay core may be accomplished with equipment commonly used, but under certain conditions may be done more rapidly with dynamite. Dynamite is particularly effective where the earth is saturated with water—the wetter, the better—and where it would be impossible to use other methods. Holes, 12 to 20 inches apart, should be driven down to solid earth (rarely more than 16 inches below the surface). These holes should be charged with dynamite made of 50 percent straight glycerine, to be set off with an electric battery in order to obtain the greatest

Figure 2.—Details of dike construction showing outlet structures.

- A. Channel to be dammed.
- B. Layout of base of the dam.

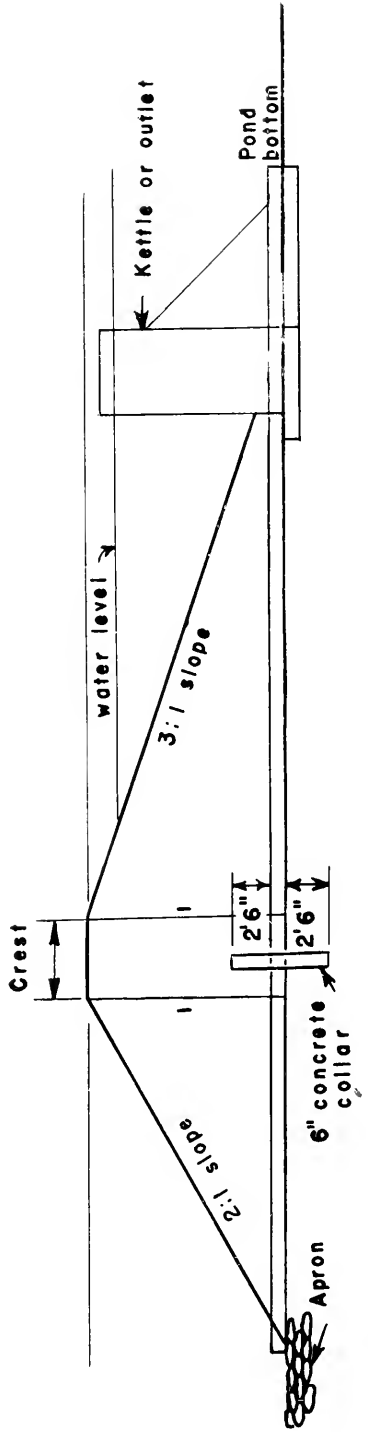
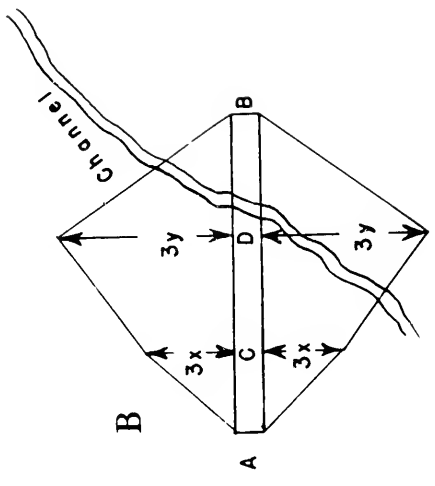
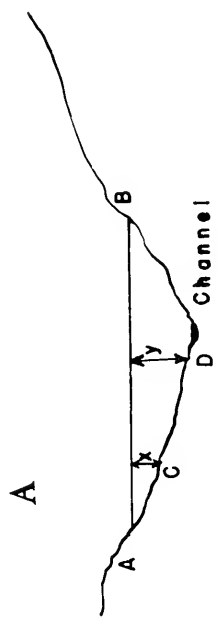



possible lifting power. The "propagation" method may be used where the soil is very wet. By this method one cap is used to set off the first stick and the others are exploded by the shock of the first charge. If the soil is not wet, a cap should be used for each charge. The time needed to construct a ditch in this way is less than that required by other methods.

By the time the previously described work is completed, the soil types available should be known with some degree of accuracy. Only first-class clay or clay soils should be used for filling the trench which has been excavated. This cut-off wall or core should be built up several feet through the center of the dam. The better, more impervious soils that are available for construction should be used directly under the center of the dam and on the upstream side. Less desirable or lower-quality earths, such as sand, stone, gravel, and so forth, may be used in the fill, but they should be incorporated only on the downstream side of the highest point in the dam and extending to the toe; so placed, these poorer earths provide weight to prevent slipping and are at the maximum distance from the saturation point of the water.

In building small dams or where there is first-class clay soil, it is unnecessary to construct a core through the dam. The same result may be effected, after the whole area of the base is plowed, by removing the topsoil down to solid earth on the upstream half of the dam and properly placing it on the lower half. The solid earth should then be plowed so it will bind with new earth moved in. Thereafter, the builder should follow the same construction procedure recommended for a dam in which a core is made.

After the base has been properly prepared, the drain line should be laid. A shallow excavation to solid earth should be dug from the proposed pond outlet to a point below the dam. Earth, the best clay available, should be firmly packed around the pipe, particularly on the under side. Addition of water to the soil to form a stiff mud will facilitate a firmer pack in the tamping process. At some central point in the dam, a concrete collar should be poured around the pipe. This prevents water from following the pipe and developing leaks; it also prevents burrowing animals, such as crayfish, from following the pipe. After the pipeline has been set up, construction of the dam may go forward.



Figure 3.—Typical pond using run-off as source of water.

- A. Bad overflow design
- B. Good overflow design.

Earth from somewhere within the pond area can be used to provide dirt for constructing the dam. Most of the soil for the dam should be obtained in the vicinity in order to save labor. The whole bottom area of the pond should be deepened and graded to drain properly, and soil should be removed from all the pond edges so that the water has a minimum depth of approximately 2 feet. Earth taken from the edges and not used in the dam may be used for sloping the bottom of the pond so it will drain properly (fig. 3).

Earth can be properly placed on the fill by keeping the fill higher on the edges than in the middle. If this is done, there will be no tendency for equipment to spill over and earth can be dumped the proper distance from the edge. Dirt should first be dumped about 2 feet from the upstream or inside toe stakes and about 18 inches from the lower or downstream stakes. This procedure will save labor by making a natural slope. Conversely, all cuts with the scraper should be made deeper at the edges than at the center. This prevents the equipment from sliding away from the banks, a possibility which might result in a ragged slope.

Fill placed on the dam should be properly compacted. Maximum compaction is effected by putting earth in place in thin layers and traveling the full length of the fill each time. On high dams special compacting equipment, such as a sheepsfoot roller, is needed and the required density is obtained by the control of moisture content. Although compacting reduces the amount of settling, allowance should always be made for it.

The actual process of constructing a series of hatchery ponds is somewhat different from building a dam, but the method of placing and compacting the material is the same. The slope on the dikes between the ponds may be uniformly 2 to 1. Where there is a series of ponds, it will be necessary to make only the dams or levee on the outside of the series water-tight through use of a clay core or other method of close binding with the clay subsoil. However, all levee bases should be properly prepared by clearing off organic debris and plowing the entire area.

The design of a hatchery is dependent on the size, shape, and topography of the land on which it is located. If the plot of land is properly sloped, ponds may be planned in such a way that sufficient earth can be removed from the pond site for the embankments. Ideally, the ponds should be from 1/4 to 1 acre in

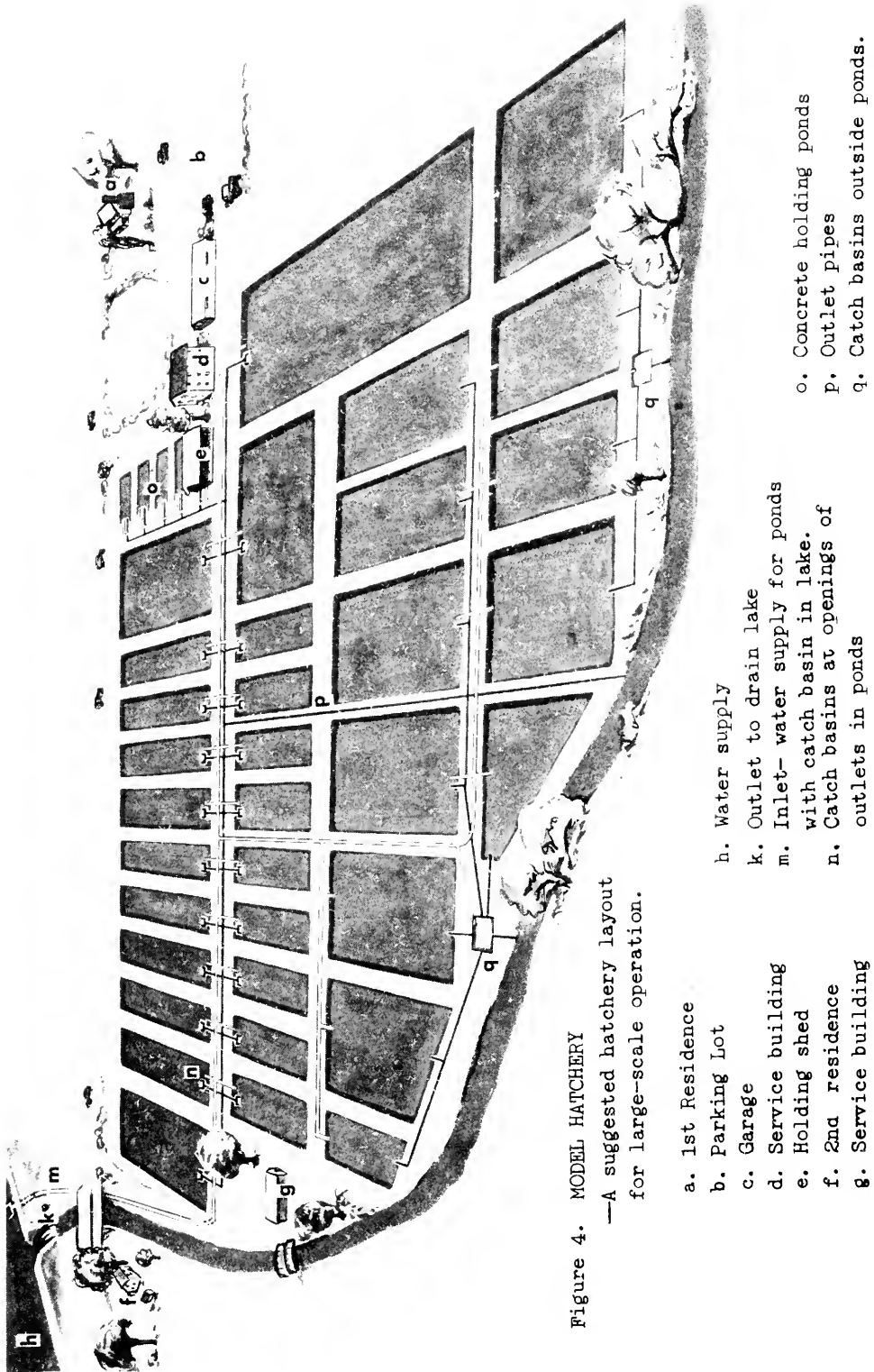

Figure 4. MODEL HATCHERY  
 —A suggested hatchery layout  
 for large-scale operation.

- a. 1st Residence
- b. Parking Lot
- c. Garage
- d. Service building
- e. Holding shed
- f. 2nd residence
- g. Service building
- h. Water supply
- k. Outlet to drain lake
- m. Inlet- water supply for ponds  
with catch basin in lake.
- n. Catch basins at openings of  
outlets in ponds
- o. Concrete holding ponds
- p. Outlet pipes
- q. Catch basins outside ponds.

area, but the topography of the land will dictate to some extent the size of pond that is constructed most economically. Under no circumstances should there be any large number of ponds of an acre or more in size. Small ponds are handled more easily and are generally more productive (fig. 4).

Plans for excavation and for the placement of drains and water lines should be made by a competent engineer. All elevations, all stakes for drain and water lines and for the dikes, should be placed before excavation starts. The drainage lines are generally placed in or through the levees so that it is essential to have these lines in place before pond construction starts. The drainage lines always lead from the deepest part of the pond to a convenient watercourse that will carry off the drainage water.

Ponds should be so constructed that the minimum depth at the shallow end is about 2 feet. Ponds to be used for propagation purposes should be sloped so that they are at least 5 to 6 feet deep at the outlet. Ponds used for holding fish through the winter must be at least 10 to 12 feet deep in the northern States. However, the size of the pond will to some extent determine the depth at the outlet.

The pond bottom should be sloped from the sides and ends toward the center and the center sloped from the shallow end to the outlet. The grade through the center of the pond should be not less than 1 foot for each 100 feet of pond length. Where a series of hatchery ponds is being constructed, the ponds are partly above and partly below natural ground level.

The type of equipment most economical to use for excavating a series of ponds depends upon the size of the job and the distance that earth must be moved. Horse-drawn equipment is economical only for small jobs and short hauls but may be used for larger jobs if it is the equipment available. With horses, a slip scraper may be used economically for moving as much as 50 feet but for more than 150 feet the cost is so great that some other type of equipment should be considered. If horses are used at longer distances, a four-horse-loaded, two-horse-transport wheeler should be used.

Maximum efficiency may be obtained with perhaps a 35-dhp (D-4) tractor bulldozer at distances from 100 to 150 feet and where the grade is not more than 5 percent. As the grade increases, the efficiency of a bulldozer decreases rapidly. A self-loading, carrying-type scraper should be used at distances greater than these.

Figure 5.—Canfield pond outlet.

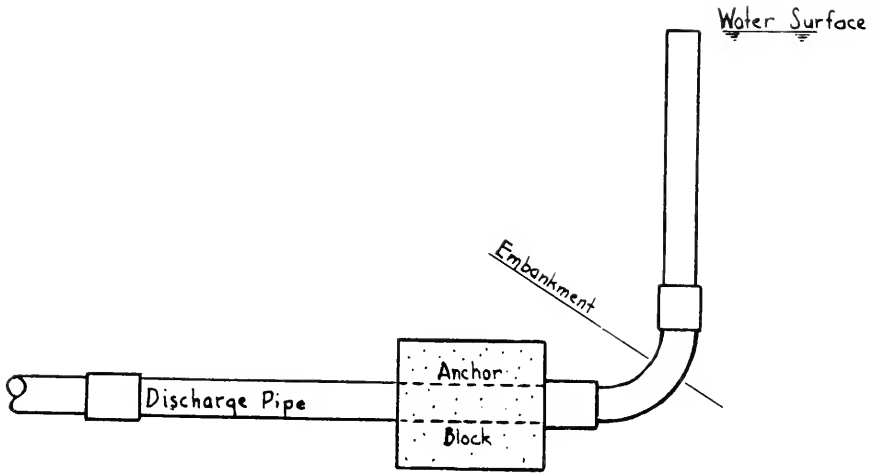
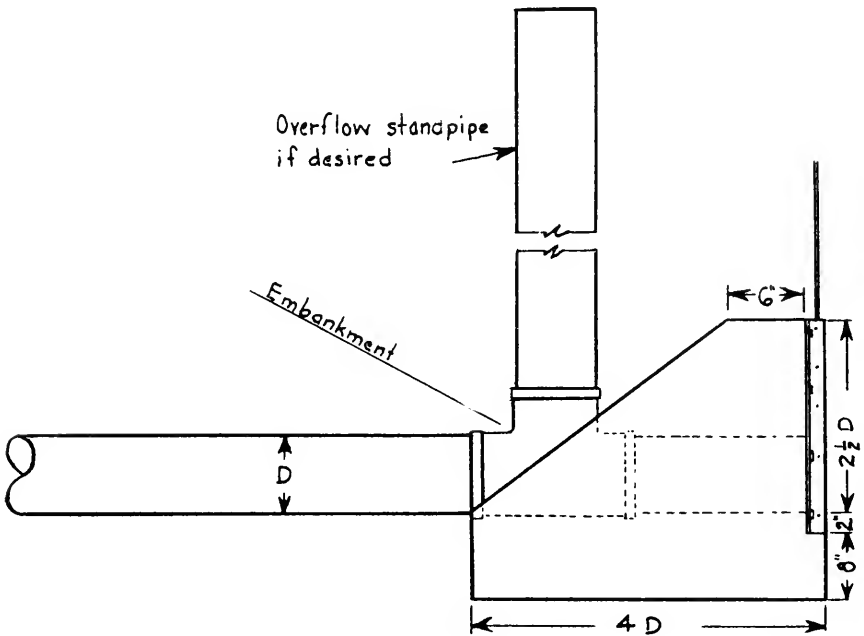

Figure 6.—Suggested cement block pond outlet.



On larger jobs, or where hauls are more than 500 feet, a 113-dhp track-type tractor is more economical. Of course, availability of equipment may be the decisive factor in most cases.

## STRUCTURES

Types of structure to be used in conjunction with hatchery layouts are largely a matter of opinion, but experience has shown that general designs are more advantageous. Likewise, experience has demonstrated that adequate construction is more economical than skimping on sizes and materials. Thus, pipelines of sufficient size are more economical than pipelines that are too small. In the past, tile drain lines, caulked with cement, have been used extensively because the original construction cost is lower. Unfortunately, there have been many failures with these lines on account of loose caulking, the entrance of tree roots, pressure from the fill, and for other reasons.

Great advances have been made in the last few years in pipeline fabrication. Among those types recently developed, the most suitable for use as outlets and the most easily installed are spiral-welded steel pipe and asbestos-cement cast pipe. Spiral-welded pipe is light in weight, long-lasting if properly installed, and comes in long lengths. Asbestos-cement pipe comes in shorter lengths but can be cut with a saw, and the joints have considerable flexibility. It is not subject to corrosion, so its utility is almost indefinite. Standard fittings can be used with both kinds of pipe, and they can be utilized for both drainage and water lines.

In ponds  $\frac{1}{4}$  acre or less in area, the drainline should be not less than 6 inches in diameter; and in ponds  $\frac{1}{4}$  to  $1\frac{1}{2}$  acres, the line should be not less than 8 inches. Use of large drainlines has a number of advantages, including savings in time and labor and frequently a saving in fish (which may be lost otherwise through high temperature, suffocation, muddy water, etc., in the draining process).

Every pond should be equipped with an outlet structure of some type. This outlet or kettle serves a number of purposes. It acts as an overflow where rain or other inflow of water raises the pond level above normal, and in the process of draining the pond the outlet holds back the fish so that they can be

removed when the water level has fallen to a depth that the operator can wade.

In small impoundments which are to be drained infrequently, one of a number of outlets may be used. The Canfield outlet is the most commonly used. It consists merely of a pipe cut to the proper length so that it will act as an overflow and control the pond level. This pipe is inserted in a 90° ell attached to the drainline and can be tipped to the desired level to drain the pond. This outlet and a modification are shown in figure 5.

Another outlet is merely a cement block laid around the outlet pipe, attached to which is one of a number of gates (fig. 6). The most common is the usual irrigation gate, which may be purchased for about \$15. A homemade gate may be made by bolting a channel iron to the block on either side of the opening and inserting a piece of boiler plate which fits over the opening and has a handle welded on it. This may be made by a blacksmith.

Research workers at Auburn University (Ala.) have designed an inexpensive gate which is attached to the bell of a piece of soil-pipe. This costs from \$8 to \$12. At present, they are experimenting with an adaptation which is attached to a 45° ell so that it can be opened by pulling a wire on shore. This eliminates the need for a platform to the outlet, which must be located in the pond beyond the toe of the levee and at the lowest point in the bottom. If the pond is to be drained frequently, one of the standard outlets for hatchery ponds should be used.

Hatchery ponds should be equipped with an outlet which will readily permit drainage and removal of fish that have been propagated. There are two general types which may be adapted to conditions. One type has the outlet and water-control structure inside the pond and the catch basin for collecting fish outside. The other has the outlet kettle and catch basin inside the pond.

The conventional catch basin and outlet are shown in figure 7. Built of concrete, this structure makes it possible to control the water level and to drain the pond. The outlet is at the low point in the back of a concrete chimney or outlet box. It should extend about 10 inches above the pond level.

The chimney usually has two sets of slots. The outer slots are provided for a screen, which prevents fish from leaving the pond and debris from entering the pipeline. The screen is made of hardware cloth on a



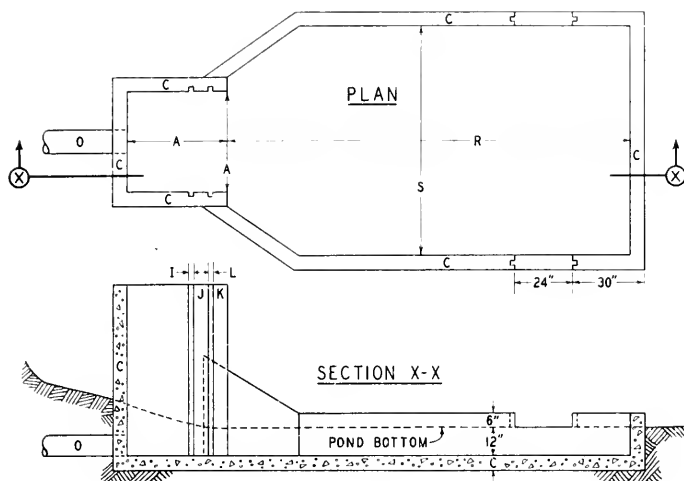

POND ACREAGE	A	C	I	J	K	L	O	R	S
1/4 OR LESS	30"	6"	1 1/2"	6"	1 1/2"	6"	6"	10'	6'
1/2 - 1 1/2	36"	6"	1 1/2"	6"	1 1/2"	6"	8"	12'	6'
2 - 3	42"	6"	2"	6"	2"	6"	10"	14'	8'
4 - 8	48"	8"	2 1/2"	6"	2 1/2"	6"	12"	16'	8'
10 - 15	54"	8"	3"	6"	3"	6"	15"	18'	10'

Figure 7.—Plan of catch basin

wooden frame which fits into the slots. The screen may be as fine as 8 meshes to the inch or as coarse as 4 to the inch, depending on the use to which it will be put.

The second slots are for dam-boards or stop-logs. These are usually made of 2- by 8- or 10-inch treated, finished lumber, and beveled on either end to fit. The boards are placed one over the other up to the desired water level in the pond, and they serve as an overflow where rainfall or other water may raise the pond above the desired level. These boards may be kept tight by small wedges inserted at either end of the upper board. Sometimes mulch or wet sawdust is thrown in front if there is considerable seepage around the boards.

An alternative type of construction is a solid concrete wall 18 to 20 inches ahead of the outlet in the outlet box to the height of the water level and about 10 inches below the top of the chimney. In the bottom of the wall is an opening opposite the outlet provided with an irrigation gate or a homemade gate as shown in figure 8. The chimney should be provided with slots for a screen.

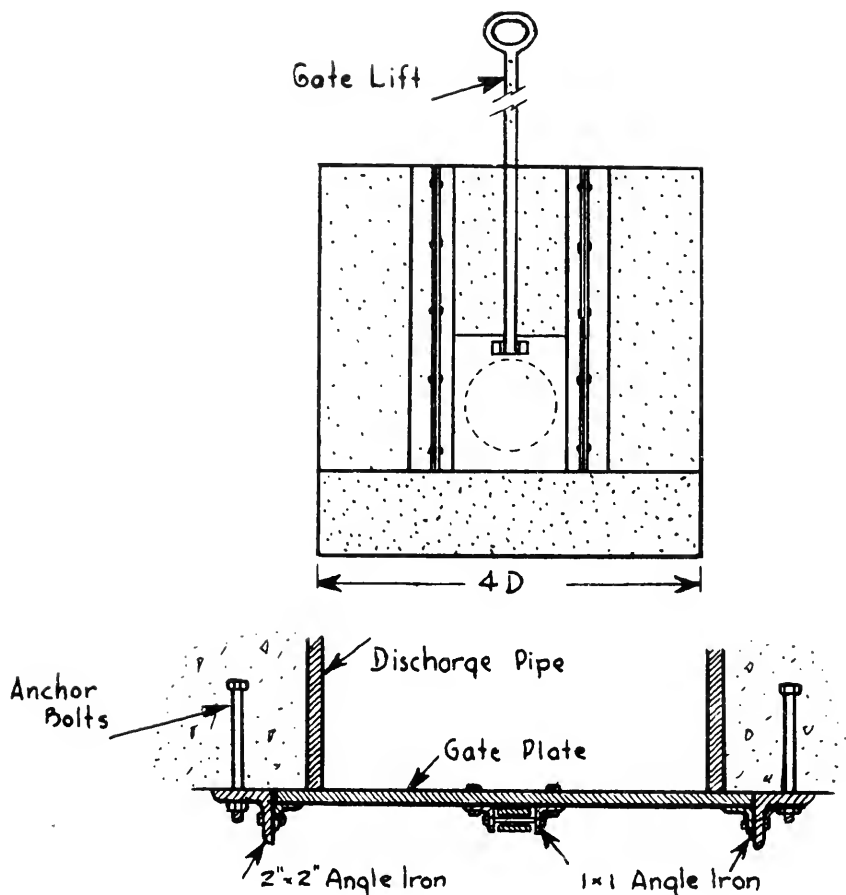

Figure 8.—An inexpensive pond outlet gate which can be constructed with materials on hand.

The type of construction that should be used is a matter of preference. The solid wall provides a tight outlet with an easily manipulated outlet gate. On the other hand, the dam-boards or stop-logs can be removed at will and the water level can be kept at any desired point in the pond. It is also true that when the pond is being drained, if an irrigation or other gate is used, the total pressure of the water is against the screen and should it become blocked with debris (as is generally the case), the screen may be broken. If dam-boards are used, they are removed one at a time and the pressure is only the depth of the flow over the board: screens seldom become entirely blocked and are never broken by pressure; also, there is no loss of fish by great pressure against the screen.



Figure 9.—Collecting basin constructed outside the ponds.

To every outlet box there is attached a kettle or catch basin, which should be about 10 inches deep and should extend above the bottom of the pond. Experience has shown that most of the fish can be removed with a seine as the water is being drained, but some receptacle should be provided for the last few fish. The catch basin and outlet combination should be set at the toe of the levee and halfway down one side of the pond at the deepest end.

An alternative type of construction involves the use of an outlet box and the catch basin at some point outside the pond. The outlet box is similar to that designed for a natural pond and does not require the use of a screen. All the water is drained through the outlet to a catch basin outside the pond (fig. 9).

The outside seining or catch basin is a concrete tank constructed in such a way that water from the pond outlet flows into it. Grooves are provided for a screen and dam-boards. Where the outlet from the pond comes into the seining basin, it is provided with an irrigation gate or valve which may be shut when desired.

Most of the water from the pond is drawn through the seining basin until a considerable number of minnows come into it from the pond. The outlet valve to the pond is closed and the water in the basin lowered until the majority of the minnows can be removed to suitable receptacles. This operation is repeated until all the water has been drained from the pond and all the minnows have been removed from the seining basin and placed in holding facilities.

Where ponds are in a series along a watercourse or grouped in such a way that a number of pond outlets can be brought into the seining basin, this type of construction is more economical because more than one pond can be drained into the basin. If there is a large group of ponds, the situation may not lend itself to this type of construction because only one pond can be drained at a time. Where there is a basin in each pond, more than one pond can be drained at a time. This is often a very desirable procedure.

Water lines supplying the ponds should be of sufficient size to fill the pond rapidly and to maintain water levels. At least 4-inch, preferably 6-inch, lines should be run to each 1-acre pond. The main supply lines from which these are taken can be designed in accordance with the number of ponds supplied, the amount of water pressure, and other factors. Cement-asbestos pipe is ideal for the main supply lines. These lines should be laid in the dikes at the proper stage in construction.

There is some difference of opinion regarding the proper location of the water-supply lines to the individual ponds. Where the seining or catch basin is located in the pond, the supply line should be located at the basin. This permits the use of fresh water when the pond is being drained and when the pond water is muddy from frequent agitation. It also provides a source of fresh water to fill receptacles which are used for transporting fish from the pond. Except in those ponds used for the propagation of stream-breeding species such as the creek chub, there seems to be little in favor of having the water supply at the end opposite the outlet.

#### Natural Ponds

In some localities the bait dealer will have to use natural ponds for the production of minnows because of the lack of suitable locations and water supply for

artificial ponds. A natural pond may not produce so many minnows per acre as the artificial pond, but where the cost of purchase or rental is reasonable, such a pond can be very profitable.

Natural ponds available for the production of minnows vary greatly in size and shape, but the small, shallow pond can be expected to produce a larger number of fish per acre than the large, deep pond. This is due to the availability of a greater area of productive bottom for the volume of water, and to the more thorough harvesting of the fish. The ideal pond ranges from 1/4 to 1 acre in size. Most natural ponds are dependent on surface run-off for water supply, and many go dry during the summer. Before a pond can be used for producing minnows, the bait dealer must make certain that the pond maintains a depth of water to sustain fish life throughout the growing season.

Natural ponds vary greatly in fertility. Ponds located in rich farmland are usually productive; ponds on poor, rocky soils are infertile unless the run-off includes a large quantity of organic pollution. The natural fertility of the pond is largely determined by the hardness of the water. Medium hard to hard water will produce more pounds of fish per acre than soft water. The amount of bloom and vegetation in the pond is a good indication of fertility: the richer ponds have a greener bloom.

Seining conditions in natural ponds must be considered before a pond is selected. There is no profit in raising minnows that cannot be harvested completely. Ponds with bog shores, steep banks, or soft bottoms should be avoided unless there is at least one firm-bottomed beach that slopes gradually enough for good seine landings. A pond full of trees and brush is impractical to operate.

In winter when these shallow (4- to 5-foot deep) ponds are covered with ice and snow, the production of oxygen by the plants in the water will drop so low that the available supply will be exhausted rapidly and the fish will smother. Throughout most of the Lake States a natural pond 15 feet deep will often winter minnows but they may freeze-out during unusually severe weather. When a good current of water can be maintained throughout the winter, the pond need not be more than 6 feet deep.

Sometimes the bait dealer has no choice but to hold minnows in shallow ponds. During open winters with little snow, this is possible because the ice, whether

clear or slightly opaque, will transmit enough light to keep the plants actively supplying oxygen. During winters of early and heavy snows, it will be necessary to keep the ice clear of snow. Hasler, Thomsen, and Neiss (1946) recommend the following method: "Winter kill may be avoided by removing the snow beginning with the first snowfall and continuing throughout the winter. To do this, simply chop a hole in the ice, lower an intake hose of a centrifugal pump powered by a small gasoline engine. Spray the water about until the snow melts on three-quarters of the pond area. The newly formed ice will transmit enough light so that the microscopic plants can replenish the oxygen supply."

### Selection of species

There are many factors to consider in choosing a bait species to raise. Several species should be reared if the dealer expects a sustained income from his operations. Several species, if properly selected, will provide suitable sizes through most of the year. As a general rule, a beginner should raise only one species in each pond.

The following characteristics should be considered in selecting a bait species for propagation:

a. The fish should be reasonably tolerant to seining, handling, and transporting.

b. Fish must have a rapid rate of growth. Even then, some species must be held more than one winter in northern latitudes.

c. The adults must be large enough to be suitable bait for the predominant game fish of the region.

d. The species should have an extended spawning season.

e. The fish should be prolific in reproduction.

f. The fish should *not* be excessively cannibalistic.

g. The fish should be resistant to the harsher fish diseases.

h. Those species lacking spines and hard parts are most suitable.

i. The minnow should be one that thrives under cultivation.

j. The fish should be suited to the ponds available.

k. Keeping qualities are of the utmost importance.

l. Species that are hardy on the hook sell best. None of the bait species will fill all these con-

ditions, but all the points should be considered when choosing a fish to raise. Often popular demand will dictate the kinds which can be raised and sold. The fish preferred for propagation in the Lake States are suckers, northern creek chub, northern red-bellied dace, western golden shiner, northern fat-headed minnow, and blunt-nosed minnow.

### Operation of the minnow pond

The first and most important step in the operation of a minnow pond is to provide food for the fish. The practical methods of doing this are by fertilization to increase the supply of natural foods and by artificial feeding.

#### FERTILIZATION

The object of fertilization is to produce minnow foods in large quantities at the time they are needed most by the fish. When manure or commercial fertilizer is added to pond water, a small amount of nitrogen and phosphorus is dissolved in the water. The minute plants (algae) which often give a greenish color to pond waters utilize this nitrogen and phosphorus. When they die and decay, the food stored in them becomes available to the minute animals (protozoa) in the water. Minute animals are the food of the waterfleas and rotifers, which in turn are the main foods of the important bait minnows. For maximum growth of the fishes this food chain should be started early and be maintained throughout the growing season.

In the spring it is desirable to get the chain started as soon as possible. Barnyard manure is used because it decomposes very rapidly. Manure should be applied at the rate of 400 to 1,000 pounds per acre, depending on the fertility of the pond. Dried sheep manure can be used at half the rate of fresh manure. The proper time of application is 2 weeks before the pond is to be stocked with adults, so that a heavy bloom is ready for the adults and young of plant-eating (herbivorous) minnows.

During the growing season the bloom should be maintained by the addition of commercial fertilizer at the rate of about 300 pounds per acre per season. The applications should be at 2-week intervals or as often as needed to keep up the bloom. A rule-of-thumb to

determine the amount of fertilization is to keep the water colored so that a hand is not visible at the depth of 1 foot. Artificial feeding and fertilization should be done at the optimum rate because excess fertility in the pond not only wastes the food or fertilizer but will endanger the oxygen supply.

When soft-water ponds are fertilized, it will be necessary to add agricultural limestone to the water to maintain proper alkalinity. A rule-of-thumb for liming ponds is to add half as much limestone as fertilizer.

#### FEEDING THE MINNOWS

The alternative to fertilization is artificial feeding of the fish. The usual procedure is to feed the fish all the ground food they will eat in 2 hours. Ponds operated under artificial feeding have such large populations of fish that food cannot be allowed to remain longer than 2 hours without danger to the water's oxygen supply. One successful food formula contains 15 percent cottonseed meal and meat scraps mixed with 85 percent of middlings. Another formula contains 100 pounds of beef melts, 50 pounds of dry dog food, 50 pounds of whitefish meal, 6 pounds of salt, and water enough to make a good feeding consistency. Fifty pounds of carp can be substituted for 25 pounds of fish meal. A formula that produced large numbers of minnows in Michigan is mixed as follows:

<u>Product</u>	<u>Pounds</u>
Cooked cornmeal and oatmeal -----	275
Bone meal -----	200
Clam meal -----	400

Maggots can be provided by putting fresh-meat scraps in a screen-bottomed box, which is placed over the pond so that the maggots can fall into the water.

Many minnow ponds will produce a large number of crayfish from natural stock that either migrates into the pond or hibernates in the pond bottom. Some species dig so deeply into the soil that draining the pond does not kill them. In many localities the crayfish can be sold for bait (p. 78), but where there is no demand, ground crayfish make excellent minnow food. Such food is usually available only at the fall harvest time, but it can be fed to the fish in winter holding-ponds or used for fertilizer on the pond bottom. Crayfish can be controlled by the use of crayfish traps baited with meat.



At least twice as many fish can be raised per acre of water by artificial feeding. Consequently, only half as many ponds are needed to produce a good supply of minnows. Though the cost of production is higher when the fish are fed artificially, this may be offset by a reduction in the original cost of the pond and in the annual maintenance. The artificial feeding of heavy fish populations (over 2,000 pounds per acre) requires a constant flow of water through the pond for aeration and cleanliness. Only a small part of the natural pond fertility and very little of the fertility available from the decomposition of food wastes are used. Such concentrated populations must be treated for disease at frequent intervals. The Michigan Institute for Fisheries Research has developed a combination method whereby creek chubs are artificially fed and suckers are raised on the bloom produced by the decomposition of the feeding wastes. The cost of production is lower than for other methods.

#### STOCKING THE POND WITH ADULTS

A very important step in operating the pond is to stock it with the correct number of brood fish. Minnows that are pond-spawned are stocked as adults seined from streams or lakes in the spring before the fish have had time to spawn. Because of the uncertainty of the natural supply, it is desirable for the dealer to hold the brood stock from year to year. The available information on stocking rates is included in table 1.

Table 1.—Recommended rates for stocking of adult minnows

Fish-culturist	State	Species	Recommended number per acre
Raney (1941) Bureau of Fish Propagation	New York	Silvery minnow	714
Wasko <sup>1/</sup>	Minnesota	Fat-headed minnow	1,500
	Ohio	Fat-headed minnow	5,000
		Golden shiner	1,800
Hasler (1946)	Wisconsin	Fat-headed minnow	1,000
Viosca (1937)	Louisiana	Golden shiner	500 to 1,000

<sup>1/</sup> Notes on bait propagation by Harold Wasko. Ohio Div. of Conserv. and Nat. Res. Leaflet 156, 2 pp. (mimeographed).

When selecting fish for brood stock, the dealer should attempt to get an assortment of sizes. The male fat-headed and blunt-nosed minnows are larger than the females, while the male golden shiner is smaller than the female. If only the largest specimens are selected, the pond will have an uneven sex ratio. A 50-50 ratio is preferred, but a preponderance of females is satisfactory for fatheads.

## STRIPPING MINNOWS AND SUCKERS

Suckers and minnows that spawn in running water (creek chub, stone-roller, black-nosed dace) are usually stripped and the eggs hatched in jars. Surber (1940) provides the following instructions for the stripping of suckers and minnows:

Stripping minnows is a somewhat delicate task for a beginner but the knack is soon acquired and the breeders handled without serious injury. Anyone familiar with the spawning operations conducted annually at one of our trout hatcheries, or field stations operated for the taking of pike eggs, will appreciate the similarity of the task. When the breeders are seined from either pond or stream, the seine should not be lifted from the water but the ripe fish, males and females, assorted from beneath the surface, and only those ascertained to be ready for spawning sorted out and placed in containers, all unripe fish being immediately released for another day. If those selected for stripping do not give their eggs and milt freely, under light pressure with the thumb and forefinger, moving downward over the abdomen toward the vent, they should also be released, as eggs produced by force will not prove fertile. The males of both minnows and suckers mature somewhat earlier in the season than the females, and the bulk of them may have moved higher up stream than the point at which the bulk of the females are taken, resulting in a scarcity of males: both sexes would be available, however, in ponds. In any event, do not attempt to take the eggs unless a ripe male is immediately available for fertilizing them.

Hold the fish over a dampened pan when expressing the eggs, and immediately after the eggs are taken strip the milt from a male over the eggs after which the mass of eggs and milt should be gently stirred with the fingers so as to assure the sperm reaching all the eggs in the mass secured. Four or five pairs of fish may be stripped into one pan, repeating the stirring after each batch of eggs and milt is added, when, after the lapse of 2 or 3 minutes, water may be slowly added to the pan and the stirring continued at intervals by whirling and rocking the pan gently to and fro. After about 10 minutes the milt may be washed

out of the egg mass by frequent changes of the water in the pan, when the entire mass can be transferred to a larger container for transportation, or directly to hatching trays or jars, if the stripping is done in the immediate vicinity of the hatchery.

Sudden jars and shocks must be carefully avoided, as the eggs will not withstand abuse of this kind. Where eggs are to be transported any considerable distance, they should be allowed to stand for several hours, with frequent changes of water in the interval, before being transferred to kegs or deep pails for transportation.

It has been previously shown that water temperatures control the season at which all fishes spawn; it also controls the development of the embryo, and, therefore, the period of incubation. Both minnows and suckers hatch over a definite period of time, this period being absolutely controlled by temperatures; in high temperatures (65 to 80 deg. F.) in 4 to 6 days, in low temperatures (50 to 60 deg. F.) in 10 to 15 days, and below 50 deg. not at all. A sudden sharp drop of even 10 degrees often proves fatal to both eggs and newly hatched fry.

Taking eggs and fertilizing them from the common sucker is simplicity itself; here brute strength is one necessary feature, because the sucker is not only large but one of the most active and powerful fish for its size native to our waters. On the upper Mississippi and its tributaries they literally swarm during May and June over the shallow, rock stream bottoms in swift water, as well as along the rocky, wind-driven shores of many of our northern lakes. Near the close of the spawning season, in deep pools at the foot of rapids on which these fishes spawn, the writer has observed literally bushels of their eggs collected; they having been washed down stream by the strong current and lodged there, for eventual hatching.

It is no trouble at this season to seine the ripe fish from these spawning beds and take and fertilize their eggs by the millions, if found necessary. Many millions have been so taken by the State Game and Fish Department in recent years, and without any particular care transported, either in ten-gallon cans, or in regular transportation cases, on cloth trays, a distance of 250 miles and hatched over 90%, in some instances as high as 99%.

In handling green sucker eggs it is well to bear in mind they must be allowed several hours to harden after being fertilized and washed, otherwise the eggs, if placed in jars too soon have a tendency to adhere en masse and then float up as far as the faucet feeding the jar will permit. If this happens the only remedy is to pour the mass of eggs into a screen of proper mesh, floated in a tub of water, and work them through, after which they can be returned to the jar and given no further attention beyond the observation necessary to see the proper

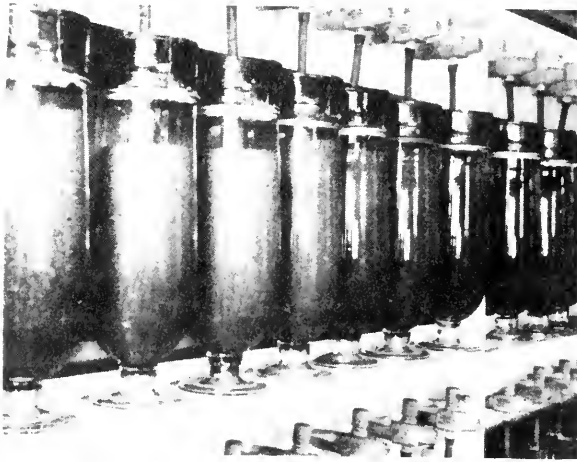

Figure 10.—A battery of jars for hatching sucker eggs.

Minnesota Conservation Department

flow of water is maintained through the jar. While the eggs may be handled on trays, far better results will be attained by the use of Meehan hatching jars, such as are in universal use for handling pike and whitefish eggs (fig. 10).

Best operation of the battery is obtained by placing not more than two quarts or 100,000 sucker eggs in each jar. After hatching, the fry will remain in the jars for several days before they are free-swimming and can go out through the overflow. A higher percentage of survival can be expected if the fry are removed from the jars and placed in clean tanks of metal or concrete. The perforated metal baskets which are used for trout fry are often used to hold sucker fry until they are free-swimming.

#### STOCKING THE POND WITH FRY

Stream fishes such as the sucker, creek chub, and common shiner are usually stocked as fry. By this method the young fish do not have to compete with the adults for food and are not preyed upon by the adults.

The rate of fry planting varies with the type of feeding employed in the pond and with the age of the introduced fry. Fertilized ponds and those where artificial feeding is practiced can support a larger population of fishes than natural ponds and should be stocked at a heavier rate. As the level of mortality is higher for eyed eggs than for advanced fry, eggs

must be planted in much greater numbers if an equal production of bait-sized fishes is to be harvested. Table 2 gives the recommended rates for the stocking of fry in ponds operated by various management methods.

Table 2.-Recommended rates for stocking of fry and eyed eggs

State and species	Method of pond operation	Stocking rate per acre
<u>Eyed Eggs</u>		
Minnesota sucker	Natural feeding	40,000
Michigan sucker	Natural feeding	100,000 to 500,000
Michigan sucker	Artificial feeding or fertilization	500,000 to 1,000,000
<u>Advanced Fry</u>		
Michigan sucker	Natural feeding	25,000 to 100,000
Michigan sucker	Artificial feeding or fertilization	100,000 to 300,000
Michigan creek chub	Natural feeding	40,000 to 80,000
	Artificial feeding or fertilization	100,000 to 200,000

Many Minnesota dealers have had no return from sucker fry planted in natural ponds. There are four probable reasons for this. First, there may not have been ample food for the fry at the time of planting. A questionable pond should be fertilized with barnyard manure about 2 weeks before the fry are planted. Second, there may have been a large population of aquatic insects in the pond at planting time. The back-swimmer and the water tiger prey heavily on fish fry and should be killed off 2 days before planting time (p.61). Third, the natural pond may have had a population of predatory fish or minnows at planting

time. Drainable ponds should be kept dry during the winter to prevent predators from surviving. Ponds that cannot be drained and do not freeze out in winter should be poisoned with rotenone at least 1 month before the fry are planted (see section on predator control). Seining may be satisfactory for small ponds but is not dependable for large, deep ponds. Fourth, the stocking has been done with either eyed eggs or recently hatched fry that have been placed directly in the ponds without the protection of trays.

#### NATURAL SPAWNING OF FISH IN STREAMS

Natural spawning of stream fish can be obtained in ponds that have one or more inlet streams. Usually the upper end of the spawning area will have to be screened for maximum spawning, and additional spawning riffles may have to be added to the stream. Michigan has been very successful with creek chubs on artificial spawning riffles that were constructed on the pond bottom. Creek chub propagation is discussed on page 44.

#### AIDS TO NATURAL SPAWNING OF POND FISH

Golden shiner ponds should be fertilized heavily enough so that there is a good growth of filamentous algae on which the eggs may be deposited. A new pond that has never been flooded before would probably require the introduction of algae in order to get the growth started promptly.

The fat-headed and blunt-nosed minnows need spawning boards for maximum production of nests and eggs.



Figure 11.—Spawning boards strung in pond for blunt-nosed minnows.

Ohio Division of Conservation  
and Natural Resources.

Tiles and boards can be placed in the ponds at a depth of 8 inches to 3 feet. These fishes prefer a board, rocks, tile fragments of flower pots, or stones close to a sandy shoal, beneath which the male digs a nest and the female lays her eggs (fig. 11).

## POND PRODUCTION

Months of preparation, fertilizing, and feeding culminate in the harvest of minnows, usually in the fall. In order that the minnow-culturist might gain some idea of the yield to expect from his ponds, data have been gathered on pond yields in Michigan, Wisconsin, Minnesota, and in West Virginia, where controlled tests were conducted. Tables 3 to 6 show that yields vary greatly with the species raised, geographic location of the pond, source and temperature of water, nature of the bottom, stocking rate, and the amount and kind of fertilizer used. Costs and returns likewise vary. It has been found in Minnesota that though almost as many fish are produced in some large ponds as in small ones, the actual yield declines with increasing pond-size. In large ponds, the fish are there but only a part of them can be harvested: the effectiveness of successive seine hauls decreases because of the scattering of fish between hauls and the general thinning of the population.

The Minnesota production table illustrates some of the difficulties in raising minnows. Pond No. 1 was not stocked heavily enough for maximum production. Fifty percent of the harvested fish, however, were of large size. Pond No. 3 could not be seined easily; so only a part of the production could be harvested. Pond No. 5 illustrates the poor production obtainable where a predator population is able to live through the winter. Pond No. 8 did not have sufficient screening at the outlet: the suckers could escape into the lake, and northern pike were able to move into the pond. Nos. 1 to 8 were operated by hatchery men who had years of experience in raising trout and wall-eyed pike but had not raised minnows before. The beginner in minnow propagation can expect low returns unless he understands the requirements and the best methods of propagating the minnows he desires to raise.

Two Minnesota ponds demonstrate the effect of stocking and fertilization on the pond yield. A 5-acre pond stocked with 350 golden shiners (70 per acre) was fertilized with 4,650 pounds of commercial fertilizer

Table 3.—Bait-fish production by Minnesota fish propagation unit, 1946

Pond No.	Species	Acreage	Stocking rate per acre	Fertilizer in pounds per acre	Production per acre			
					Minnow or sucker Pounds	Number of fish	Sunfish Pounds	Pickereel Pounds of fish
1	Golden shiner	5.00	70	1,020	85.6	22,734	-	-
2	Golden shiner	1.00	200	None	245.0	64,925	-	-
3	Fat-headed minnow	.50	300	1,000	54.0	25,380	-	-
4	Fat-headed minnow	1.00	250	Barnyard drainage	126.0	32,130	-	-
5	Fat-headed minnow	3.00	250	None	80.0	30,000	82.0	-
6	Blunt-nosed minnow	.66	7,207	450	450.0	180,018	-	-
7	Lake shiner	.60	5,040	3,333	245.0	60,603	-	-
8	Sucker	2.00	290,000	600	40.0	1,600	-	2.0



Table 4.—Wisconsin bait-fish production, 1946

Pond No.	Species	Fish-culturist	Acreage	Stocking rate per acre	Fertilizer in pounds per acre	Production per acre: number of fish
1	Sucker	Wisconsin Fish Management Division	1.3	38,450	4,614	10,132
2	Sucker	do.	.5	50,000	pasture	12,600
3	Sucker	do.	.6	25,050	none	1,336
4	Sucker	do.	2.3	6,525	none	—
5	Fat-headed minnow	do.	1.0	2,000	none	64,774
6	Golden shiner	do.	1.0	950	none	7,714
7	Sucker	do.	1.0	150,000	none	109,630
8	Sucker	Fish and Wildlife Service	.17	235,000	some	13,524
9	Sucker	do.	.18	166,800	some	12,232
10	Sucker	do.	.22	90,800	some	6,356
11	Sucker	do.	.22	45,400	some	4,540
12	Sucker	do.	.11	1,818	some	274,318
13	Golden shiner	do.	.11	1,818	some	192,703
14	Common shiner	do.	.11	1,818	some	38,005
15	Blunt-nosed minnow	do.	.11	2,727	some	40,632
16	Blunt-nosed minnow	do.	.11	1,364	some	21,362

and 450 pounds of dried sheep manure. An unfertilized 1-acre pond was stocked with 200 golden shiners. This pond received some fertilization from pasture drainage. The fertilized pond had a total yield of 421 pounds of fish (85.6 pounds per acre), while the 1-acre pond produced 245 pounds. This indicates that the 5-acre pond was greatly understocked and that the 350 adult fish had produced all the young possible. The average number of fish produced by each female was 650. As the females in the 1-acre pond also averaged 650 young, it is apparent that the extra space and the excess of food in the 5-acre pond had no effect on the total number of fish produced. The excess of food showed in the size of the fish at time of harvest. In the fertilized pond 46 percent of the population averaged  $2\frac{1}{2}$  to  $3\frac{1}{2}$  inches total length; in the unfertilized pond only 16 percent of the fish reached those sizes. Fish in the fertile pond grew to  $3\frac{1}{2}$  inches in 11 weeks, but fish in the poorer pond required 16 weeks.

Table 5.—Bait-fish production by Michigan Institute for Fisheries Research, 1946

Pond No.	Species	Acreage	Stocking rate per acre	Fertilizer in pounds per acre	Food in pounds	Production per acre	
						Pounds	Number of fish
1	Sucker	0.41	875,000	-	809.5	631.8	31,185
2	Sucker	0.13	1,335,000	-	347.0	461.4	30,780
3	Creek chub	0.46	38,700	300	-	102.6	19,891
4	Creek chub	0.48	32,000	-	-	112.5	23,333
5	Creek chub	1.82	-	-	776.5	182.4	32,335

#### Time of Harvest

Minnows are harvested only when they have reached suitable size for bait. With some fast-growing species such as suckers and golden shiners, a few may be removed late in their first summer and others may remain in the ponds until the second summer. Seining in the fall when the weather is cool, is easier and offers less injury to delicate minnows, although demand is less at that time and holding tanks are necessary to keep the fish until the winter fishing season.

The Institute for Fisheries Research at Ann Arbor (Mich.) has developed a technique for harvesting golden shiners during warm weather. The fish are caught in a drop net with cheesecloth webbing and are handled with a scap that is also hung with cheesecloth. The fish must be hardened in cold water for 24 hours before they can be transported (p.72).

Table 6. ---Production of forage minnows in the Fish and Wildlife Service ponds at Moorefield, W. Va. <sup>1/</sup>

Year	Pond No.	Acreage	Species	Number of fish per acre	Pounds of fish per acre	Kind of fertilizer used	Pounds of fertilizer in season	Cost per pound	Total cost
1941	1	0.49	Golden shiner	204,082	820.0	Cottonseed meal	464	\$0.018	\$ 8.37
	4	1.11	Blunt-nosed minnow	97,297	181.0	Cottonseed meal	1,568	0.018	28.22
1942	1	0.49	Blunt-nosed minnow	81,947	266.0	Cottonseed meal	319	0.025	7.98
	-	-	Golden shiner	-	-	-	-	-	-
	-	-	Fat-headed minnow	-	-	-	-	-	-
	3	0.76	Fat-headed minnow	529,739	201.0	Inorganic 9-9-2 superphosphate cottonseed meal	345	0.014	4.83
1943	4	1.11	Fat-headed minnow	487,928	655.0	Cottonseed meal	737	0.025	18.43
	3	0.76	Blunt-nosed minnow	46,399	139.20	Soybean meal	300	-	8.10
			Fat-headed minnow	13,470	40.41	Superphosphate	150	-	1.65
			Total	59,869	179.61			-	9.75
	4	1.11	Common sucker, 4.5" Golden shiner, 2" Blunt-nosed minnow Black-headed minnow Total	1,265 72,976 30,049 202,331 306,621	31.53 130.63 62.61 223.42 448.19	Soybean meal Superphosphate - -	440 220 - -	0.0270 0.01075 - -	11.88 2.42 - - 14.30
1944	4	1.11	Common sucker, 3.9"	13,932	306.51	Soybean meal superphosphate	396 198	0.0248	14.74

<sup>1/</sup> By Eugene Surber.

## Size of Fish

In order to avoid producing fish of unsuitable size or large fish at a season when there is no market for them, the fish-culturist should attempt to plan the yield before the pond is stocked. The following points should be considered:

1. What species of bait fish is in the greatest demand.
2. What sizes are most desirable?
3. What volume of fish will be needed during each month?
4. During which months will it be possible to harvest the minnows without undue loss and too great expense?
5. What facilities are available for holding minnows for long periods?
6. Will food costs permit holding for extended periods?
7. Will selective grading be possible periodically through the season?

It must be understood that in any pond great variations in minnow lengths will occur. Table 7 presents data on the size of species of various ages in different localities.

Table 7.—Size of bait fishes at various ages

Species	Locality	Average length of bait species in inches						
		1 month	2 months	3 months	4 months	5 months	1 year	2 years
Golden shiner	Minnesota	1.0	2.2	3.5	-	-	-	-
Fat-headed minnow	do.	1.0	1.4	2.2	-	-	-	-
Blunt-nosed minnow	do.	-	-	-	-	-	2.25	3.0
Sucker	do.	-	-	2.5	3.5	-	4.0	-
Golden shiner	Wisconsin	-	-	-	-	3.0	-	-
Blunt-nosed minnow	do.	-	-	-	2.0	-	-	-
Sucker	do.	-	-	2.0	-	-	-	-
Golden shiner	Michigan	-	-	-	-	1.6	2.5	3.25
Sucker	do.	1.0	1.3	2.5	3.8	5.0	8.0	-
Creek chub	do.	1.0	1.5	2.5	3.2	-	5.0	7.0
Fat-headed minnow	do.	-	-	-	1.4	-	-	-
Fat-headed minnow	Ohio	0.25	0.5	0.88	1.25	1.5	-	-
Sucker	New York	1.0	1.5	-	3.0	4.0	-	-
Lake emerald	Illinois	-	-	-	-	-	1.75	3.0

The problem of rearing enough fish for use during the first summer is a very real one in northern latitudes. Suckers usually are available for bait during July and August, but 25 to 50 percent of the golden shiners in a pond will be too small for sale at the time of fall harvest. The smaller fish should be sorted out and held for growth the second year. Fat-headed and

blunt-nosed minnows often are not of usable size until July of their second season. In extreme cases of overcrowding, the fish will not grow to maximum size even with plenty of food available.

### Grading of Fish

Periodic grading or sorting of fish throughout the growing season will reduce the number of small fish that have to be held through the winter and will result in greater production of desirable bait-size minnows.

The most practicable method suggested for grading minnows, with the least amount of injury to the fish involved, is by the use of a mechanical grader, similar to those used in trout culture, consisting of a wooden box containing a bottom of tubular grating. These tubes of light-weight metal, having a diameter of about 1/4 inch, extend across the bottom, producing a sieve-like structure. By regulating the spacing between the tubes, certain sizes of minnows can be retained in the box or allowed to pass through. If the minnows are to be graded into several sizes, several grading boxes will be necessary, one for each size-group in minnows desired.

### AQUATIC VEGETATION

Plants are necessary in minnow ponds for food, spawning locations, shelter of fry from predatory adults, and reduction of predation by birds and snakes. Algae of the unicellular and filamentous types are easily controlled plants that will supply these needs. Though suitable also for some of these functions, submerged plants should not be encouraged because they are difficult to control and may take over the whole pond at the expense of fish production. Too many plants will choke the pond to the extent that an oxygen depletion may occur on hot, still nights. Submerged plants often completely cover the shore feeding and nesting areas and make them unsuitable for the fish. A heavy growth of plants uses up a large percentage of the pond fertility in a form that is not available to the fish as food, and a pond choked with weeds is extremely difficult to harvest.

There are three methods of controlling submerged vegetation in ponds. The most practical is by heavy fertilization. A pond that is subject to weed trouble should be fertilized early in the season so that a heavy

bloom forms before the plants start to grow. The bloom must be heavy enough to shade out the rooted plants and should be maintained throughout the season. A bloom thick enough so that the bottom cannot be seen at the depth of 1 foot is heavy enough for this purpose. The pond will have to be watched closely, as there is danger that the bloom may become heavy enough to cause an oxygen depletion during warm nights. This method has the advantage of producing fish food while controlling the weeds.

In some ponds fertilization may not control the weeds and hand cutting will be necessary. In shallow ponds a scythe will be the most satisfactory tool, but in deep ponds one of the mechanical weed cutters is necessary. When possible, the vegetation should be raked up on the banks to prevent an oxygen depletion when it decomposes.

Weeds can be killed by solutions of copper sulphate and sodium arsenite that are too weak to kill the fish, but this method should be used only as a last resort because either of the chemicals will kill most of the minnow food organisms. These chemicals should not be used without the supervision of a trained biologist.

Two or three hundred carp placed in a small pond during the winter will eliminate all the weeds. This procedure is prohibited by law in most States and cannot be undertaken without special permission because of the danger of introducing carp in forbidden waters.

A new chemical (Butyl Ester of 2,4-Dichlorophenoxy Acetic Acid, usually called 2,4-D) has been effective in killing emergent vegetation. The chemical 2,4-D is sold under various trade names as a dandelion killer. For use on aquatic vegetation a solution of 1 part of 14 percent active ingredient 2,4-D to 130 parts of water is used. One part of Vatsol (a wetting agent) should be added to each 2,000 parts of solution to reduce the surface tension and thus increase the wetting power of the solution. The chemical 2,4-D is applied to the plants under pressure from a hand-operated sprayer. The spray should be applied from a suitable distance so that the solution will adhere to the leaves. The plant will die even though its entire surface is not covered. The plant may turn yellow 24 hours after the application of 2,4-D but will not be completely dead for a week or two depending on the species of plant and the weather. New shoots and seedlings will come up later, and for complete control these must be killed too. The chemical

2,4-D has very little effect on fish and other aquatic organisms.

### Special considerations in the propagation of suckers

Preliminary studies on the propagation of suckers for use as bait, conducted by the Institute for Fisheries Research, Michigan Department of Conservation, have led to development of the following methods:

Sucker eggs are commonly obtained by stripping ripe fish (p. 28) or by collecting fertilized eggs from lakes and streams where natural spawning has occurred.

In many lakes, suckers are known to spawn along the wind-swept gravel shoals, where the eggs tend to concentrate in shallow water as a result of wave action, and can be collected with scap nets. In streams where suckers spawn on gravel riffles, the eggs can be collected by stretching a fine mesh net across the stream below the nesting area. The gravel in the riffles is agitated to dislodge the eggs, which are then washed downstream into the net.

In collecting sucker eggs, it should be remembered that these fish do most of their spawning at night and that the most opportune time to collect would be on the following morning. Repeated collections are usually necessary to obtain a large quantity of eggs. After each collection, the eggs should be washed through a 1/4-inch cloth screen to remove the larger debris and egg clusters and immediately placed in a hatchery jar at the rate of 3 quarts of eggs per jar. The flow of water necessary for successful hatching will vary, depending upon the number of eggs in the jar, but will generally range from 1 to 3 gallons per minute. The water temperature should range between 50° and 60° F. During the hatching period, each jar in operation should be attended once daily. The fungused eggs (white in appearance) will collect on the top of the egg-mass, forming a collar which can be siphoned off into another container. If any clusters of eggs appear, the whole contents of the jar should be washed through a 1/4-inch mesh cloth net and the clusters removed or the eggs separated.

When the eggs become eyed (a moving embryo visible within the shell) they should be removed from the jars and placed one to three layers deep on screened trays located either in a hatchery trough containing running water or in a pond scheduled for stocking. If the eggs are to be incubated further in the hatchery, the trays

should be made of 14- by 18-mesh screen. This gauge of screen will adequately retain the eggs during final incubation and at the same time allow the newly hatched fry to escape into the trough. During the final period of development, the eggs should be hand-picked each day to remove all dead and fungused eggs. This daily operation should continue until a majority of the eggs are hatched. The newly hatched fry (cream-colored) can be seen lying on the bottom of the trough. Within 4 to 6 days, however, the fry attain a dark coloration and can be observed swimming near the surface of the water. They are then ready to be passed to rearing ponds.

In direct pond stocking with eyed eggs, specially constructed trays should be used. The trays should have a rigid framework consisting of sides, bottom, lid, and legs. The sides should be 6 inches high, covered with a fine-mesh screen (24 to the inch) or cheesecloth. The bottom should be covered with the same kind of material to prevent escape of the newly hatched fry. The lid, however, should be covered with a much coarser screen (12 meshes to the inch) to allow escape of the advanced fry. Upon introduction of the eyed eggs the lid should be inserted and the tray submerged about 1 foot under the surface in about 3 feet of water. A tray containing 4 square feet of bottom area will readily accommodate 1 to 2 quarts of eggs (30,000 to 60,000 individual eggs). During the final incubation period, a feather should be run through the eggs each day to change their position and to disclose dead eggs or debris.

A word of caution to the beginner: If at all possible, it would be advisable to purchase either eyed eggs or advanced fry rather than attempt to propagate them. In this way the fish-culturist can be assured of some success and at the same time learn more about the trade.

Several factors have to be taken into consideration before pond stocking is attempted. The operator should decide whether he wishes to stock with eyed eggs or advanced fry and whether he plans to feed the fish, to fertilize the pond, or to let the fish forage for themselves in natural pond water. Further, the operator should know what size suckers are desired by prospective purchasers, as well as how soon he will need salable stock.

Preliminary studies in Michigan have indicated that when eyed eggs of the sucker are stocked in a rearing



pond, the return from salable bait will average not more than 10 percent, ranging from less than 1 percent to about 25 percent. When advanced fry are stocked, the returns are much better, amounting to 50 percent of the number of fry planted. However, the drawback in the stocking of advanced fry is the necessity of skilled workmanship and experience to transfer these fragile fish successfully. It is therefore recommended that the beginner stock with eyed eggs, unless he can purchase advanced fry, until he becomes familiar with fish-cultural techniques.

In ponds where no artificial feeding is planned, the stocking rate can range from 100,000 to 500,000 eyed eggs, or between 25,000 and 100,000 advanced fry per acre, depending upon the natural fertility of the pond being used. Naturally, the richer ponds can be stocked at a heavier rate. The size of the suckers developing from this type of stocking will vary with pond fertility, ranging from 2 to 8 inches in length at the end of a 100-day growing season. Ponds stocked with eyed eggs during the latter part of April or with advanced fry in early May will yield salable fish by July and continue to produce throughout the season. In order to have salable fish available in July, the operator must net and grade his fish. As fish derived from the same planting of eggs are known to grow at different rates, there will be many sizes of suckers in a pond by the latter part of August. It is desirable and recommended that the fish-culturist start grading the minnows as soon as a sufficient number are of salable size. In this way, the fastest-growing fish will be removed, leaving more food for the smaller ones.

The stocking rate of ponds where food is provided can range from 500,000 to 1,000,000 eyed eggs or 100,000 to 300,000 advanced fry per acre of water. If eyed eggs were used for stocking and a good hatch occurred and the pond appears to be overstocked, some of the fry can be removed to other waters. Sucker fry should be fed as soon as they become interested in artificial food. At first the food should be very finely ground and introduced sparingly along the shore in shallow water. As soon as it is evident that the fish are consuming the food, the amount can be increased. The quantity of food to be given each day will depend entirely upon the amount consumed by the fish. No more should be fed than the fish will consume in a 2-hour period. However, suckers should be fed an amount sufficient to

require about 2 hours to consume. During the first 4 or 5 weeks, sucker fry can be fed in the morning, as they will consume artificial food during the daylight hours. Beyond this age they have a tendency to feed at night and the general feeding routine should be shifted to late afternoon.

Suckers can be fed almost any type of food. The protein-carbohydrate ratio can range from a 50-50 basis to as high as 15 percent protein to 85 percent carbohydrate. Some excellent foods for suckers are clam meats, liver, horse meat, canned or raw fish, egg yolk, wheat, corn, and oats. The food should be finely ground, water added, and well mixed before feeding. The amount of food consumed by a large population of suckers is enormous. A stock of 100,000 3-inch fish in good condition can be expected to consume more than 100 pounds of food per day.

Large numbers of salable suckers will be available earlier from ponds where direct feeding is practiced than from ponds where no artificial feeding is conducted. The practice of grading and sorting the stock should be commenced as early as possible.

When draining a sucker pond for complete removal of fish, a few precautions must be taken. In the first place, the water level should be reduced slowly to allow the fish to move with the water and to prevent them from getting stranded on weedy or shoal areas. In the final operation, regardless of whether the fish are captured by seining directly from the pond or first driven into a seining basin, care should be exercised to prevent roiling the water. Suckers cannot tolerate waters that are excessively muddy and will soon die if exposed to these conditions. As a precautionary measure, a small stream of fresh water should be allowed to enter the pond as soon as the water becomes roily and the suckers start to show signs of distress.

#### THE MICHIGAN METHOD OF CREEK CHUB PROPAGATION

The tenacity of the creek chub makes it a good minnow for handling, holding, and transporting; it can tolerate, to a considerable degree, exposure to sudden temperature changes in water. The artificial culture of this species, at present, is not an easy task. A suitable spawning area (running water in a gravel-bottomed stream) must be provided where natural spawning can occur, or the breeders must be stripped and the

fertilized eggs incubated in a hatchery. The first method of raising them offers the most promise of success to the beginner; in the second situation many difficulties have been encountered which require skill and patience to overcome. The study of the creek chub has led to the development of methods of propagation, but it must be understood that these methods have not been thoroughly tested and are, undoubtedly, subject to many improvements.

#### PREPARATION OF A SPAWNING RACEWAY

The general layout of an area for the culture of creek chubs consists of a stream emptying into a pool. The stream provides the spawning space, and the pool acts as a refuge area for the breeders during the spawning season and later as a collecting basin or a rearing pond for the newly hatched fry. In Ohio a successful raceway prepared for the propagation of creek chubs consisted simply of a gravel-bottomed stream and base pool confined within the basin of a pond covering an area 143 feet long, 13 feet wide, and from 1 to 3 feet deep. Starting at the inlet, the upper 24 feet of the pond were filled with fine soil to create a steeper slope, upon which a meandering channel (27 feet long, 27 inches wide, and 2 to 10 inches deep) was prepared. At places in the dirt fill where there was apt to be some washing by current action, heavy reinforcing material was used. The channel (bank and bottom) was covered with a heavy layer of gravel. Water supplied by an 8-inch inlet passed down the stream channel and into the base pool below, which was formed by impounding the water in the remaining portion of the original pond basin.

In Michigan a creek-chub spawning raceway prepared and successfully used was also built within the basin of a pond and likewise consisted of a stream and base pool. However, the design of the stream was radically different from that used in Ohio. The sequence of the Michigan construction was as follows: (1) the excavation of a main channel; (2) installation of refuge zones at 25-foot intervals along the stream; (3) surfacing of the entire raceway with gravel; (4) installation of splash boards (check dams) at 25-foot intervals; (5) regulating the stream flow, the height of the splash boards, and the water level of the base pool; (6) placing covers over the refuge pits; and (7) erection of

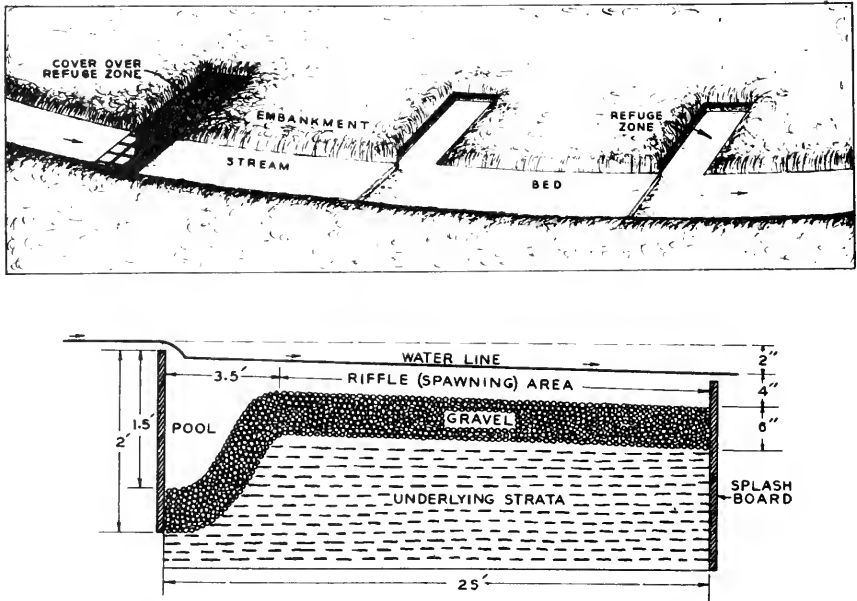

Figure 12.—Typical raceway construction for spawning chubs.

- A. Diagrammatic view of stream bed and shelters.
- B. Cross section of spawning area.

Michigan Conservation Department

netting over the stream bed for control of predatory birds.

The main channel (6 feet wide, 1 foot deep, and 300 feet long) was dug within the basin of a 1.8-acre pond. Starting at the inlet, following along the base of one of the dikes, the excavation gradually descended (8 inches fall per 100 lineal feet) into the basin of the pond. The materials removed from this ditch were placed on both sides of the channel, forming 1.5-foot banks. At intervals of 25 feet along the course, rectangular pits (2 feet deep, 3 feet wide, and 8 feet long) were prepared. These pools, hereafter to be referred to as refuge zones, crossed the stream bed and extended into one of the banks for a distance of about 4 feet (upper drawing, fig. 12). That portion extending into the bank was curbed to prevent filling by erosion. At this point of construction the entire stream, including those portions of the refuge zones lying within the channel and both banks, was surfaced with a 6-inch layer of washed gravel (1/4- and 3/4-inch

screened stones in equal proportions). About 38 cubic yards of gravel were used to surface the 300-foot raceway. Immediately after the spreading of the gravel, splash boards (lower drawing, fig. 12) were installed across the channel at each refuge zone. These structures (boards) were driven into the bottom soil to a depth of 1.5 feet and were exposed about 3 inches above the gravel. The purpose of these devices was twofold: one, to act as a break against the continuous current—resulting in the formation of areas of slow and fast moving waters and thus simulating conditions used by chubs as spawning areas in natural waters; and two, to prevent the refuge pools from being filled by washing gravel. In order to determine to what degree these splash boards were accomplishing their purpose, the inlet valve of the pond was opened to allow 1.5 cubic feet of water per second to flow down the stream channel as a test. Some splash boards projecting too high above the stream bed (forming interfering barriers) were lowered; others, too low to be effective in checking the current and preventing wash, were raised to the desired height. Following these alterations, the outlet valve was closed and the water allowed to accumulate within the basin of the pond until it reached a level even with the lower end of the stream (fig. 12). At this point, after sluice boards had been installed in the outlet to maintain this height, the outlet valve was opened and the overflow water allowed to pass through. As the last task in preparing the pond for brood fish, the refuge zones were covered with lids made of tarred paper and strips of lath, and netting (fig. 12) was stretched over the stream.

Anyone contemplating the propagation of creek chubs need not construct a raceway exactly duplicating either of the two just described. It is important to take into account when constructing a spawning stream the ecological conditions affecting the breeding habits of the creek chub, such as currents, pools, hiding places, and types of bottom soil. As life-history studies show that the creek chub prefers certain types of habitat, it is desirable to provide these conditions as completely as possible. Raceway streams can be made any length desired; the width does not necessarily have to be confined to 4 or 5 feet, provided that a sufficient volume of water is available to operate effectively a wider channel. The most important thing to consider is the water supply. The water should be clear in color, have a temperature range of 55° to 60° F. during

the spawning season, and be free from other species of fish.

#### SELECTION AND INTRODUCTION OF BROOD STOCK

An operator selecting brood stock must bear in mind that the male chub grows larger than the female; that the mature male is distinguishable from the female by the presence of bony protuberances (horns) on the head immediately before and during the spawning season; and that the male is usually highly colored during the spring, having tinges of red on the paired fins and abdomen. In contrast, the adult female is generally smaller and more drab in color than the male and has a swollen abdomen during the spawning season. Results of Michigan studies in the selection of brood stock indicate that it is advisable to use 6- to 8-inch males and 5- to 6-inch females for breeders. If larger males (7 to 10 inches in length) are available and the total stock could be represented by fish of this size, results should prove satisfactory. Likewise, if larger females (6 to 8 inches in length) are available, they could also be used. It is not advisable to mix small (5-inch) mature males with larger (10-inch) males in the same raceway, as sizes thus mixed are not suitable and mortality occurs as a result of fighting. Where small (3-inch) females were mixed with larger (8-inch) females in the same raceway, a prolonged spawning season occurred, resulting in a loss of fry. The larger females matured about 2 weeks earlier than the smaller ones: by the time the latter were through spawning, many fry had hatched and emerged from the earlier-formed nests. The presence of fry in the raceway and base pond before the brood stock is removed, naturally complicates their removal.

One more suggestion to be presented at this time concerns the age of adult fish. Normally only a few pond-reared creek chubs can be expected to mature in their first year and to be used as breeders. In the second year, possibly 50 percent will mature (depending upon the rate of growth, the larger fish being the most favored); as a result, most of the brood stock will have to be selected from older fish. In natural waters, female creek chubs normally do not mature until their fourth year and males not until their fifth. It is evident that creek chubs are not long-lived fish, rarely exceeding 6 or 7 years.

The next important step in the culture of creek chubs is the stocking of the raceway with breeders. Recommended stocking rates calculated on a theoretical basis derived from observations and studies conducted in Michigan may or may not be entirely satisfactory for all types of raceways. It is believed, however, that a brood stock should contain more females than males (approaching a ratio of 2 to 1 or 3 to 2). Furthermore, each female in stock composed of 3.5- to 7-inch fish should be provided with 1.5 square feet of spawning area for egg deposition, and for each female from a group composed of 4- to 8-inch chubs 2 square feet of area are needed. In calculating the square feet of available spawning area in a raceway, the margins along the banks (about 3 inches on each side of the stream) and any areas used for refuge zones or current deflecting structures should be omitted. Generally, about one-fourth of the total area will be consumed by these structures. To illustrate the use of these recommendations, let us suppose that an operator had a raceway 200 feet long by 4 feet wide and wished to determine the number of breeders necessary for stocking. Assuming that one-fourth of the total area would be consumed by the banks, refuge zones, and other structures, he would have to make his calculations upon the remaining 600 square feet of stream bed. If 3- to 7-inch females were used, about 400 of these would be required, and 200 males would be required if a sex ratio of 2 to 1 were established or about 266 males if a 3 to 2 ratio were followed. If 4- to 8-inch females were used, 300 would be needed and the corresponding ratio of males would be included. The mortality rate of adult creek chubs during the spawning season has been exceptionally high, sometimes amounting to as much as 75 percent. To be assured that an adequate supply of adult fish will be available each spring, provision should be made whereby a new group of fish will be maturing each year.

Creek chub breeders should be introduced into the raceway at a time when this species is known to be spawning in nearby natural waters. If a check cannot be kept on the natural spawning or if no natural spawning occurs in the area, it is advisable to introduce the fish when the water temperature in the raceway has reached 55° F. for a 2- or 3-day period. Creek chubs usually start to spawn during the latter part of April in waters north of an imaginary line drawn east and west from the Michigan-Ohio border. Spawning is terminated late in May or early in June in the Lake Superior area

but continues into July in northern Minnesota. The nesting season for any one locality usually lasts about 3 weeks.

As soon as the chubs in the raceway are through spawning (no activity on the beds for 2 or 3 consecutive days with water temperature  $55^{\circ}$  F. or higher), they should be removed from the stream and base pool. If no young fish (fry) have appeared, all structures in the raceway can be removed; the adult fish in hiding can be driven into the base pool, which in turn can be drained, and the adults easily removed. However, if fry are present, the breeders will have to be driven from the stream and taken by seine in the base pool. As soon as the brood stock is removed, fry screen (60-gauge), if not installed earlier, should be placed in the outlet. Within 10 days after the breeders have been removed, more sluice boards can be placed in the outlet to raise the water level to normal pond height and inundate the entire spawning raceway. As soon as the pond is filled, the incoming flow can be reduced to a point just sufficient to maintain a constant level. If the raceway is not constructed within the basin of a pond, the incoming water supply should not be reduced until all the eggs have hatched and the fry have moved into the base pool, a process which normally would require an estimated 20 days after cessation of spawning activity.

As soon as the fry concentrating in the base pool become conspicuous and are grouped in schools along the shore, they can be collected with a bobbinet seine and transferred to rearing ponds. It is almost impossible to make an accurate count of the number of fry collected other than by hand-counting, which would be an endless job. About the only method which could be used for estimating numbers would be to concentrate a stock of fry in a container, such as a tub, and remove these with a quart dipper in which the estimated number per dipper had already been determined. Naturally, there would be a considerable error involved.

#### STOCKING OF PONDS AND MINNOW PRODUCTION

Information on the stocking of ponds with chub fry is meager. In Michigan, a survival rate of more than 50 percent was recorded in ponds stocked with 20-day-old fry. One pond, stocked at the rate of 39,000 fry per acre, produced about 9,000 salable minnows in a



115-day growing season; in another stocked at the rate of 32,000 per acre, 11,000 salable fish were produced in a comparable period.

Those figures seem low when compared with the output of ponds for which the stocking rate is not available. In Ohio, approximately 11,000 creek chubs, averaging about 3.5 inches in length, were produced in a 1/12-acre pond, and about 9,000 in a 1/7-acre pond. This would represent production at the rate of 135,000 and 63,000 fish per acre, respectively. In both ponds the fish were given artificial foods. In Michigan, a 1.8-acre pond produced 58,000 chubs, a yield of about 32,000 per acre. From general analysis of the data on hand, it would seem that a pond could be expected to produce from 100,000 to 200,000 salable fish per acre per year if artificial feeding was practiced, or by fertilization if an equivalent amount of available food could be provided by this method. In ponds (not fertilized) where the fish had to rely on natural food for growth, it is doubtful that more than 50,000 could be expected per acre of water. When stocking rearing ponds in anticipation of a certain production, consideration should be given to normal mortality (25 to 50 percent).

A possible but yet untested way in which to increase creek-chub production is by the use of raceway ponds similar to those used in trout culture. These long, narrow ponds that have a continual flow of water passing through could be stocked heavily with chub fry early in the year; feeding could be started at once. As in trout culture, the daily portion of food would have to be increased, probably each week, to compensate for the increased demand of the growing fish. Further to increase production, about once a month or oftener the chubs should be graded according to size groups and the larger ones sold (if of salable size) or removed to some other pond. By removing the larger fish, the competition for food will be reduced and the small chub will have a better chance to obtain his share. It is believed that there would be several advantages in raising creek chubs in this manner: first, less area would be needed for pond construction; second, the fish could be sorted and harvested easily; and third, there would be less food wastage. The probable disadvantages would be the requirement of more water than would normally be needed for rearing ponds, and a higher mortality from disease as a result of crowding.

## GROWTH

The rate of growth of the creek chub is dependent to a large degree upon the type and amount of food ready and to a lesser degree upon the stocking rate. It is believed that, even though a pond were stocked very heavily with chubs, an appreciable growth would occur if an adequate supply of food was available. Michigan studies of the potential growth of the creek chub indicate that within 10 weeks after stocking with fry ponds in which a good supply of food was available, most of the fish average better than 2 inches in length; in 12 weeks they average 2.5 to 3 inches; and in 18 weeks between 3 and 4 inches. In Ohio, very heavily stocked ponds produced fish averaging 2.25 inches in about 14 weeks.

## FEEDING

It is believed that chubs being fed artificially should be provided with all the food they will consume in 1 or 2 hours, and that they should be fed every day for a good growth. The amount of food to be given to the fish in any one pond will depend entirely upon the amount consumed; by gradually increasing the daily portions until some food is left untouched, the correct poundage can be determined. In Michigan, chubs were fed a diet of cereal and ground livers at a ratio of about 3 pounds of cereal to 1 pound of liver. In Ohio, creek chubs were fed meat scrap, ground carp, and middlings, at a ratio of about 7 pounds of meat scrap and ground carp to 3 pounds of cereal. It is believed that this higher protein diet is more satisfactory than that with high carbohydrate content.

## DISCUSSION

The most important thing to do when selecting a location for a creek-chub hatchery is to formulate plans for the number of minnows to be raised, to determine whether or not there is a sufficient volume of water available at this location to operate the needed number of raceways and rearing ponds. Results from creek-chub studies in Michigan indicate that with a fair amount of success in fish culture, about 800 fry may be expected for every female creek chub introduced into a spawning raceway. In Ohio, each female introduced into a spawning raceway in 1941 gave a return of about 400

salable fish, and in 1942, about 450 salable fish per female. As we have some idea as to the spawning needs for the female chub and can roughly calculate the number of females which will satisfactorily stock a specified raceway, a crude estimate can be made as to the number of females and the size of the raceway which will be necessary to realize a set production figure.

As a possible aid to the creek-chub producer in estimating the number of chubs per pound, table 8 is presented.

Table 8.—Creek chubs per pound at various lengths<sup>1/</sup>

Length in inches (average)	Number per pound	Length in inches (average)	Number per pound
1.71	530	2.47	192
1.74	512	2.53	190
1.91	376	2.62	177
1.97	320	3.10	90
2.05	297	3.70	43
2.17	266	4.19	37
2.18	242	4.26	31
2.39	206	4.86	18

<sup>1/</sup> These figures are derived from representative samples of fish taken from 8 ponds used in creek-chub studies in Mich.

### Disease and parasite control

When minnows are raised in ponds under hatchery conditions, they can be expected to suffer from many of the diseases of hatchery fishes. For this reason it seems wise to mention some of these diseases, parasites, and predators, and to outline briefly a program for prevention and cure. Moreover, diseased and ailing fish are often collected by unsuspecting dealers, or the fish may become fungused from improper handling in the nets or tanks.

The best method of disease control in a hatchery is prevention. Minnows that are handled properly and that are adequately tempered before handling will usually be free from disease (p. 72 ).

## HOST-PARASITE RELATIONS

Bait fishes have been reported infected by several kinds of parasites:

Number of parasite species reported from fishes	
Golden shiner -----	14
Common shiner -----	3
Blunt-nosed minnow -----	9
Fat-headed minnow -----	2
Eastern silvery minnow -----	2
Common white sucker -----	20
Western mud minnow -----	4

Most of these diseases and parasites will not cause loss, and only a few are characteristic enough for the private hatcheryman to recognize. Those likely to cause considerable loss are fungus disease, fin or tail rot, and the black grub.

## CONTROL OF SPECIFIC DISEASES

*Fungus disease.*—Fungus disease of fish is usually attributed to an organism called *Saprolegina parasitica*. At the point of infection the fungus appears as a greyish-white fuzz. This spreads rapidly over the body surface, and the fish is sometimes almost completely enveloped before death occurs. It is a common disease of fish, especially in warm waters or in tanks. The focus of infection is usually traceable to some injury which permits the entrance of the spores. This disease is controlled in nature by certain bacteria which are found in the mud and ooze of lake and pond bottoms. Infected fish from tanks should be dipped for 5 minutes in a concentrated salt solution (p. 57). In stubborn cases the treatment can be repeated several days in succession. A 10-second dip in malachite green 1:15,000 (1/8 ounce in 15 gallons of water) is very effective.

*Fin rot.*—Fin rot may be caused by several bacteria. The disease is characterized by a progressive degeneration of a fin or the tail of a fish until the entire appendage is destroyed. The infection starts at the free end of the fin. The diseased tissue is separated from the uninvaded tissue by a white line. Control of

this disease is accomplished by dipping in a 1:2,000 solution of copper sulphate (6.5 ounces to 100 gallons of water) for 1 or 2 minutes. Specimens on which the disease has progressed to a marked degree should be destroyed, as the dip can do little for them. Bacterial fin rot has also been controlled with a 1:4,000 (8 ounces to 100 gallons of water) solution of formalin used as a dip for 1 hour.

*Black grub.*—Black grub or black spot is caused by the larval form of the flatworm, *Neascus* sp. The parasite occurs on fishes as a small black spot about 1/25 of an inch in diameter. This black cyst encloses a small worm which is usually limited to the scales and integument but which may occasionally be found in the flesh just below the skin. The life history of the black grub is complicated but is typical of many of the flatworm parasites. The adult worm occurs in the kingfisher. Eggs of the worm are discharged into the water, where they hatch into small free-swimming organisms. These larval forms swim about until they come in contact with a particular species of snail. Then they bore into the snail and reproduce themselves many times. Finally, numbers of free-swimming forms break out in the water and move about until contact with a fish is made. They then burrow in and encyst in the scales or in the flesh. When the fish is eaten by a kingfisher, the encysted worm develops into an adult and the life cycle is completed. It usually causes little damage to the fish but may, at times, be present in numbers large enough to cause death.

Klak (1940) reports a heavy *Neascus* infestation of fat-headed minnows in a pond at Leetown (W. Va.). The encysted worms were found in the abdominal cavity in such numbers that the abdomen was greatly distended. Mortality was so high that a change to golden shiners, a more resistant species, was recommended.

The only controls for this parasite are draining the pond long enough to kill the snails, and controlling the kingfisher population.

*Ligula intestinalis.*—This is a tapeworm whose last larval stage is commonly found in the body cavity of suckers and minnows and rarely in perch, darters, and bass. Infested fish are easily recognized by their swollen bellies; worms 6 inches long have been taken from minnows, and worms as long as 12 inches have been

taken from suckers. The adult stage lives in the intestines of water birds.

Minnows and suckers reared in ponds or taken from shallow waters along lake shores may be infested. The parasite is known to be of wide occurrence in the Great Lakes and adjoining areas. Because the parasite eggs are spread by water birds and early larval forms live within natural food organisms of fish, there is little chance for permanent control although drying and freezing of pond bottoms may reduce chances of infestation.

*Lernaea* sp.—Suckers and minnows held in sluggish or warm waters may develop what appear to be raw circular wounds with a slender bone-like splint projecting from the center of each lesion. The white splint actually is a copepod parasite which has burrowed headfirst into the flesh, usually beneath the dorsal fin. This parasite is common in southern portions of the Lake States and is more abundant southward.

The projecting portion of the parasite contains reproductive organs which scatter eggs into the water as the host fish swims about. These eggs hatch into tiny free-swimming larvae which, in time, attach themselves to the exterior of another fish, transform their body-shape to a great degree, and burrow in.

Meehan was able to cure the infection on fancy goldfish by reducing the pond level to a point where water flowing into and out of the pond produced a mild current. The young which hatched did not reinfect the fish, and the adult parasites dropped off after they reproduced. Infected goldfish could be healed in about 10 days.

There are a number of ways to treat fish diseases. Fish (1938) gives a good description of the best methods for the treatment of trout. His description is presented here:

#### Methods of treatment

Regardless of the concentration of disinfectants used, the technique of application influences the success of any treatment to no small degree. It might, therefore, be advantageous to briefly outline the various methods of treatment in common use and the recommended technique for their application.

Aside from medicines administered with the food, treatments may be roughly divided into four basic methods: (1) salting; (2) flushing; (3) hand dipping; and (4) prolonged treatments.

### Salting

Salting is an ideal trough treatment except for the one limitation that it will not cure everything. In troughs, it is extremely simple to apply; it is reasonably effective against the external protozoan parasites; it is an excellent tonic to the fish; and its application demands the least accuracy of any known form of treatment.

There are many ways to salt a fish, some good and others definitely bad. My own choice, which I think as good as any and superior to most, is to determine the volume of water contained in a trough-drawn down to a predetermined depth, say two inches. By multiplying the inside length of the trough by the inside width and the product of these two numbers by the predetermined depth, all expressed in inches, one obtains the water content in cubic inches. For each 60 cubic inches of water in the trough at this predetermined depth, one ounce of finely ground salt is dissolved in a pail half full of water. To administer the salting, shut off the inflowing water, drain the trough to the predetermined depth, and spread the salt solution from the pail evenly over the trough.

Fingerling trout will withstand this concentration for six to ten minutes. When several of the weaker fish have turned over, the inflow is resumed at the maximum rate which the fish will withstand and the drain partially opened to permit a rapid replacement of the salt water. This method may be applied to fish as often as desired without apparent injury and, indeed, with a definitely tonic effect. When repeated three times at 24 hour intervals, salting is quite effective in curbing epidemics caused by external protozoans and it is the only treatment which should ever be applied in the absence of definite knowledge regarding the cause of any mortality. Salting, however, becomes progressively more expensive, less effective, and more difficult to apply as the size of the body of water to be treated increases.

### Flushing

Regarding the second method, namely flushing, which is used primarily as a preventive, very little is known - far too little to justify much comment. The method consists in routinely adding several fluid ounces of disinfectant solution of definite strength to the upper end of a trough and allowing it to flow down the trough and out. This method may have distinct possibilities. At least as now usually applied it does not appear to be toxic to the fish. However, in my own experience at least, on the only occasion which has come to my attention this method of applying copper sulphate solution definitely did not prevent an epidemic of *Gyrodactylus*. Unquestionably, this method should be further investigated under controlled conditions.

## Dipping

The third basic method, hand dipping, could be the subject of several closely written volumes. Suffice it to say that this method is a dangerous one for the solutions used are powerful and relatively concentrated, hence the difference between an effective dose and a killing one is exceedingly narrow in view of our present lack of knowledge concerning this very common method of treatment. When applied with extreme care, it undoubtedly may be of great value in controlling epidemics of external parasites and certain types of bacterial diseases such as fin rot, ulcer disease, and the eastern type of gill disease. ... Certainly, hand dipping should never be applied to any large number of fish unless there is valid reason to believe that some external parasite is causing the losses. In the absence of such reason, a dip should be applied to a small number of fish as an experiment. If the percentage loss on this isolated group does not fall significantly below that of the entire group of affected fish within two days after the experimental treatment was administered, that method of treatment should be foregone.

As for the exact technique of hand dipping, in my opinion it is best done in a dipping box. This apparatus fundamentally consists of a solidly constructed, watertight, wooden box, in cross section about two inches narrower than the hatchery troughs, about half again as deep, and approximately three feet long. The box is legibly marked at the height attained by a known volume of water. In this dipping box is slung an inner compartment, resting on four "ears" which are sufficiently wide to rest on the top of the dipping box, yet sufficiently narrow to slip into the hatchery troughs. This inner compartment is made from two wooden sides, rounded vertically at the ends and the bottom is covered with a coarse mesh galvanized wire covering. The galvanized mesh, in turn, is covered with bobbinet on the inside, the bobbinet being caught to the wire mesh at a sufficient number of points to keep the bobbinet from floating off.

In use, the desired quantity of disinfectant is weighed out and dissolved in the box filled to the calibration mark. The inner compartment is then placed in the trough containing the fish to be treated, where a convenient number of fish may be placed in it from the trough by means of a scaffold net. The compartment is then removed to the dipping box and the fish immersed in the disinfectant. After the required time for the dip has elapsed, the inner compartment is carefully lifted from the dipping box and immersed in the trough to contain the treated fish. By slowly lifting the "upstream" end, the fish slip out of the "downstream" end. The solution in the dipping box should be aerated constantly and renewed frequently. Needless to say, the temperature differences between the infected trough, the dipping box, and the treated trough should at no time exceed 5° F.



### Prolonged treatment

The fourth method of treatment, namely prolonged treatment, is based on the theory that a long exposure to a dilute solution of disinfectant is more efficacious and less toxic than is the short, concentrated handdip. Furthermore, it may be applied without handling the fish, a factor which is not serious if the fish are carefully treated from troughs but may become very much so when the fish are in ponds [concrete] where a seine must be used and a large number of fish are involved. Prolonged treatment of fish, either in ponds or troughs, does obviate this very objectionable feature. Unfortunately, prolonged treatments must still be regarded as in the experimental stage and while they are, theoretically, far superior to hand dips, we have much to learn concerning their practical application.

Prolonged treatment originally consisted of adding to the inflowing water by means of some convenient apparatus, sufficient dissolved disinfectant at a uniform rate to maintain a constant concentration of disinfectant over a definite period of time, usually one hour. This method of treating the inflowing water is subject to an inherent inaccuracy due to the diluting influence of the residual water in the pond at the time treatment is started. This inaccuracy is not serious in the case of troughs or small raceways which may be drained practically to dryness and which fill rapidly, but it becomes progressively more so as the size of the body of water to be treated is increased. For the treatment of the larger types of fish-cultural equipment such as circular pools and raceways, the most recent development in prolonged treatments is essentially identical to the method of salting described except that the disinfectant-concentration used is much weaker so that the fish may be safely exposed for a period of several hours during which time, the water is recirculated in a closed system from the lower end of the pond to the upper by means of a centrifugal pump. This assures adequate aeration during the time when the inflowing water is stopped.

### When to treat

In any method of treatment, time is of vital importance. Disease rapidly lowers the vitality of small fish and although today they may withstand the rigors of treatment, tomorrow may find them too weak. The fish-culturist must maintain strict watch on his stock. Many external parasites give early warning of their presence which is evidenced by the fish refusing to eat, scratching themselves or assuming a characteristic bluish-gray sheen. Fungus, of course, is an excellent indicator of trouble but it usually does not appear until after the tell-tale rise in the daily losses which are the surest proof that trouble is present.

Immediately upon any suspicion of trouble and always in the event of increasing losses, the fish should be carefully examined for gross lesions and all possible extraordinary factors such as bad food, silt, and sudden fluctuations in water temperature, etc., should be checked. If nothing can be found, the fish should be examined for parasites and microscopic lesions. If still no demonstrable source of trouble can be found, a few obviously affected fish should be preserved in a ten percent solution of formalin and forwarded, with full particulars, to the nearest pathological laboratory. Following this, all fish should be salted. In the early stages of disease when relatively few fish are as yet affected, these should be removed to an isolated "hospital trough" to prevent spread of the disease to the healthy fish. Needless to say, strict quarantine must be employed to keep the disease from spreading through the rest of the hatchery stock.

In table 9 are presented the formulas for several solutions used in the treatment of ailing fish.

Table 9.—Formulas for solutions

Chemical	Strength	Amount	
		Chemical (Ounces)	Water (Gallons)
Malachite green	1: 15,000	1/8	15
Formalin	1: 4,000	8	100
Copper sulphate	1: 2,000	6½ (quarts)	100
Sodium hypochlorite	1: 10,000	1	250
Do.	1: 10,000	3 Chlorox	250
Do.	1: 10,000	4½ Hilex	250

### Control of predation

#### INSECTS

Minnow ponds may become overpopulated with aquatic insects that prey on fish fry. The beetle larva called "water tiger" and the adult insect known as the "back-swimmer" (*Notonecta*) are the most destructive. As both these forms come to the surface of the water for air, they can be controlled by covering the ponds with a film of oil. Kerosene, fish oil, No. 2 fuel oil, and cod-liver oil can be used for this purpose. The

cod-liver oil must be mixed with gasoline before use. Meehan (1937) recommended using 10 to 12 gallons of kerosene per acre of water-surface. The same result can be obtained with 4 or 5 gallons of commercial fish oil. The fish oil is sprayed on the surface in order to control the thickness of the film. Kerosene becomes too thin to be effective when sprayed, so it is best poured along the windward side of the pond. These oils are not injurious to the fish.

## BIRDS

Hérons and kingfishers may cause a heavy loss of fish from ponds. Occasionally the entire production of a pond has been taken by birds. The private hatcheryman is not allowed to shoot or trap these birds; so he must depend on scares, wires, and fences to keep them from the ponds.

Hérons do not usually alight in the water; a low chicken-wire fence close to the edge of the pond or very steep banks around the pond will keep the birds out. Sometimes several wires around the pond will work as well.

Kingfishers are attracted to posts that overlook the pond. Removing all posts and dead trees near the ponds should help to discourage these birds.

The hatchery operator should try to keep predatory birds from his pond, as the heron spreads the yellow grub and the kingfisher is host to the black grub.

## SNAKES

A large percentage of the food of the common water snake and some garter snakes consists of fishes. The water snake has a preference for streams but will readily frequent fish ponds.

Snakes can be controlled by killing all that are seen around the ponds. The grass and weeds at the edge of the pond should be cut short at all times so as to deprive the snake of much needed cover. Logs, tree roots, and boulders should be removed for the same reason. Ponds that are fenced to keep out herons should be provided with pits at intervals along the outside of the fence to catch snakes and turtles. Water-snake traps are now advertised for sale in some cities.

## TURTLES

Some species of turtles are known to be fish eaters and consequently are predators if given access to a minnow pond. As a safeguard, all turtles frequenting a pond of minnows should be considered predators and controlled accordingly. Turtles can be captured with baited hooks or turtle traps.

## MUSKRATS

The only appreciable damage done by these animals results from their burrowing in the dikes of ponds. At times they can be serious pests, causing abnormal bank leakage and slipping that result in expensive maintenance costs. If a minnow producer has difficulty with these animals, he should consult his local conservation department as to methods of control. Most States have specific laws protecting the muskrat because of its value as a fur-bearing animal.

## OTHER FISHES

Predatory fishes and the adults of cannibalistic minnows must be controlled in minnow ponds. As mentioned before, lake and river water should be filtered to keep predatory fish fry from entering a pond. When possible, the minnow pond should be drained dry during the winter to kill any predatory fish that may have escaped notice. Ponds that cannot be drained should be treated with rotenone before minnows are introduced and whenever there is an indication that predatory fish have become established.

The best procedure is to apply 1.32 pounds of 6 percent rotenone powder per acre-foot of water (0.5 p.p.m.). The powder must be mixed with water to form a thin batter and spread evenly over the pond. A boat and outboard motor are usually used to apply the poison. The pond should be criss-crossed in a good pattern with lines about 50 feet apart. The rotenone batter is poured over the edge of the boat in a small stream. Propeller action gives a thorough mixing with the water. A pond shallow enough to freeze-out in winter does not need this treatment.

## HANDLING OF MINNOWS AND OPERATION OF HOLDING TANKS

While many species of fish can be found in the tanks of the bait dealers of Minnesota, Wisconsin, and Michigan, certain species are more popular and are handled in greater quantities. Those used most often are listed in table 10.

Table 10.—Fish used for bait in the Lake States

	<u>Minnesota</u>	<u>Wisconsin</u>	<u>Michigan</u>
Suckers	x	x	x
Northern creek chub	x	x	x
Northern pear dace	x	-	-
Fine-scaled dace	x	-	-
Northern red-bellied dace	x	x	x
River chub	-	-	x
Western golden shiner	x	x	x
Lake emerald shiner	-	x	x
Northern common shiner	x	x	x
Northern fat-headed minnow	x	x	-
Blunt-nosed minnow	x	x	x
Western mud minnow	x	x	-

These fish require different methods of propagation, but the handling techniques will be similar for all.

## Causes of loss

The bait dealer encounters his greatest loss when handling and holding minnows. In 1942, the Minnesota Bureau of Fisheries Research made a survey of the methods used in handling and holding minnows to determine causes of loss with the object of reducing the loss and thereby conserving minnows. The causes are as follows:

1. Minnows are often killed during seining operations. Some are crushed in the net, and the small ones are often left stranded on the beach at the conclusion of seining. Some are killed by slow and careless handling during sorting. The loss is extremely high when "soft" minnows like the golden shiner are handled during hot weather.

2. Inadequate aeration and temperature control for truck tanks cause a large loss during long hauls and in hot weather. Part of this loss is probably due

to the rapid transfer of fish from the warm pond-water to the cold water in the truck tank.

3. Holding-tank losses result from faulty tank construction, poor water supply, lack of cleanliness in the tank, indifferent disease control, and inexperience in operating the tank.

4. Overcrowding the carrying and holding tanks will increase the loss even when the best equipment is used, as there is increased injury to the fish and greater possibility of spreading disease.

5. Fungus disease causes a large loss in holding tanks, but there is some indirect evidence that the fungus is of secondary importance in this loss. Though it is known that rough handling of the fish often forms lesions through which the fungus is able to start its growth, much of the loss that is attributed to fungus is probably the direct result of tempering the fish at too rapid a rate.

6. Live boxes in lakes and streams produce a high loss because of the uneven and often violent water circulation in them. The water temperature is often too high for the safe or efficient holding of minnows.

7. A loss sometimes results when minnows are held in ponds that are not suited to their needs. A similar loss occurs when fishes that are incompatible are stored in the same pond. A knowledge of the requirements of the species will eliminate these difficulties.

### Reduction of loss

#### GOOD SEINING METHODS

Whether seining in public water or in his own minnow pond, the bait dealer should seine with the object of catching the maximum number of fish with a minimum of loss. The following suggestions are presented to help the beginner avoid undue loss.

Minnow seines, generally speaking, can be classified into three types depending on the kind of weave used in construction. The "common-sense" minnow net is made of woven threads, and with prolonged or severe use will develop "runs" caused by thread breakage and separation. This type of netting can be obtained in mesh sizes of 1/8 to 3/8 inches (bar measurement). The next type of seining fabric is constructed with a non-slip knot tie. Each mesh is individually knotted, and it will not develop runs or thread separation under the most severe operating conditions. In this



Figure 13.—Proper seining methods will prevent fungused fish.  
Minnesota Conservation Department

type of netting, mesh sizes ranging from 1/4 inch upward can be obtained. The third type of netting material used by fish-culturists and bait dealers is called "birds eye" or bobbinet cloth. This material is a fine-woven fabric and is excellent for use in collecting small fish (fry).

The net should be picked according to the job. A 1-acre circular pond can be seined very effectively with two hauls of a 200-foot net, 6 to 12 feet deep. A pond that can be drained to a seining pool can be seined much more easily with a 30-foot net. A net that is too long for the job is cumbersome to use and increases the chance of injury to the fish. For seining in public waters the net should be at least of 1/4-inch mesh so that the minnows too small for use can escape for further growth. In a small production pond a bobbinet seine can be used to transfer the small fish to a wintering pond. (fig. 13).

When possible the seine should be landed on a firm sandy bottom. The silt stirred up on a soft bottom adds to the discomfort of the fish and may cause suffocation. When there is danger of suffocation, smaller hauls should be made and the fish should be bagged and moved to deeper water as fast as possible.

When landed, the seine should never be pulled onto the shore. As soon as the fish are in the net, it should be bagged loosely and floated to deeper water. The fish should then be dipped with a small hand set (scap) into a floating live box (wooden box with a hardware-cloth bottom) for sorting.

As soon as a tankload of fish has been seined and transferred to the live box, the fish should be weighed and carried in a pail of water to the tank. The usual procedure is to hang the scale from a tripod set in several feet of water. A half-bushel metal basket is partly filled with clean water. Ten pounds of fish are weighed and carried to the truck. By weighing 10 pounds of fish at a time it is easy to keep account of the fish taken or the production of a pond. Fish handled in these amounts will not be too crowded or easily injured. If the operator is interested in knowing the number collected, he can weigh and count the fish in 1 pound (fig. 14).



Figure 14.—Production should be determined by weighing rather than by volume.



## USE OF TRAPS

Screen and glass traps are commonly used by minnow dealers. Similar in design and differing only in the construction materials, both consist of a pot and an entrance funnel or funnels. In design, the screen trap is more variable, being round, rectangular, or square, and having from one to four funnels. Glass traps usually are round and possess only one funnel entrance.

Wire traps of several designs, containing one to four funnels per trap, are frequently used by minnow dealers to collect bait. Traps of this type are most efficient when set in quiet waters and attended daily. They are baited with bread or cracker crumbs and placed on the bottom of a stream or pond or suspended above the bottom at a desired depth by the use of a stake. The traps should be attended daily and all fish removed on each occasion. If the minnows are allowed to remain in the trap for any extended period, many become injured by continued contact with the screen sides. In a pond or lake where a good population of minnows is known to exist, one wire trap, 2 feet long by 16 inches square, containing a funnel at each end, will take as many as 500 minnows in one day's operation.

Glass traps are used mainly in streams. This type of collecting gear has proved highly efficient; not only can a large number of minnows be obtained in a relatively short time, but they can be collected with little or no injury. Operation is simple. The first step is to follow along the banks of a stream until a school of minnows is located. The next step is to seek an area upstream from the school of minnows where the current is weak and the water depth does not exceed 1 foot. (These locations are usually found near the banks of the stream.) At this point a small depression, about the size of a glass trap, is gouged out of the bottom and the trap, baited with finely ground cracker crumbs, is placed in the depression with the funnel opening facing downstream. Within a few minutes, by current action, some of the food particles originally within the trap will be drifting downstream, attracting the fish below. Immediately, the minnows will move upstream toward the source of the food supply; within a half hour, the food supply in the trap will be exhausted and a number of minnows will have been captured. The minnows should be removed from the trap as soon as the food is gone, as experience has proved that the minnows will soon escape. On one stream in Michigan, four

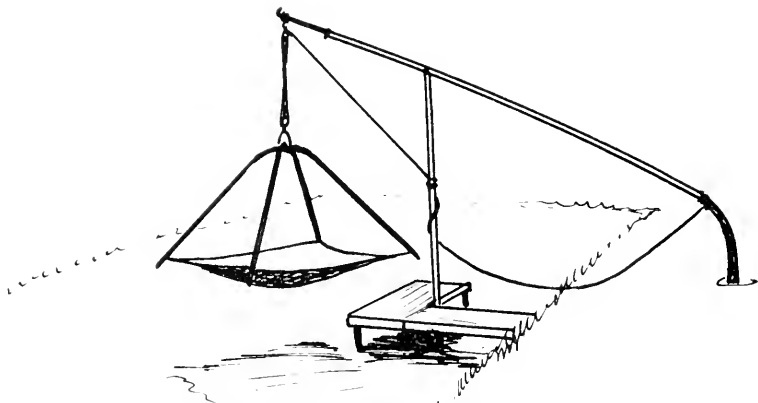

Figure 15.—A trapnet for removing minnows from the pond.

glass traps took a total of 600 minnows (2-1/2 to 5-1/2 inches long) in 1 hour. The number of minnows captured per trap per set ranged from 10 to 70. The average duration of a set (established by food depletion) was about 20 minutes.

#### USE OF DROP NETS

One of the nets frequently used in harvesting minnows from lakes and ponds is the lift or drop net. This net is usually square in design and it forms a pocket when lifted directly upwards. Sometimes the netting is supported by a rigid framework which prevents collapse when lowering or lifting the net. Guy ropes are attached to each corner to enable the operator to lift the net upward on an even keel. On occasion, instead of a rigid framework support, the netting is suspended from flexible steel bands running diagonally across the net: when the net is lowered, the bands tend to "flatten" out; and when lifted, they bend inward, creating a pocket (fig. 15).

Whether the drop net is small (3 feet square) or large (8 to 10 feet square), the principle of operation is the same. The net is lowered to the desired depth either by hand in case of the small net or by rope from a tripod and pulley for the large net; bread and cracker crumbs or oatmeal are wetted and thrown into the water immediately above the net to attract the fish. Usually, as soon as the bait has dropped to a depth equal to or nearly equal to that of the set, the net can be lifted. When the small net is used, the fish can be lifted in

the net from the water and poured into the holding cans. Where larger nets are employed, the "lift" should not clear the water but rise to a point where sufficient water will be present for ample movement of the captured fish. The fish in the net can then be transferred to the holding cans with a long-handled dip net.

Drop nets are operated successfully in quiet waters on certain species such as the golden shiner, fat-headed minnow, and creek chub. Minnows can be collected efficiently with little or no injury by this method under the guidance of a good operator. There are many advantages of using a drop net, where practicable, instead of a seine. In capture, the fish are not "rolled," crowded, or crushed; the bed of the pond is not broken nor is the bottom debris roiled to any extent. Furthermore, minnows under salable-size can be returned to the waters, uninjured. In clear waters, the drop net will work more efficiently for certain species if the netting, ropes, and frame support are dyed a natural color that harmonizes with the surrounding water. In highly turbid waters, dyeing would probably be of no material value. Where fragile minnows are being collected with the drop net, the netting material should be a soft fabric, such as cheesecloth. When this material is used, some minnows which "scale" easily, such as the golden shiner, can be harvested successfully during the hottest weather.

#### USE OF DIP NETS

The so-called "dip net" is frequently used in taking shiners in the Great Lakes. This net is usually of conical design, 1 to 2 feet in diameter at the opening, and 2 to 3 feet deep. The rigid hoop that forms the opening is fastened to a handle. The mesh size of the netting material used in construction varies, depending upon the size of the minnows to be collected (fig. 16).

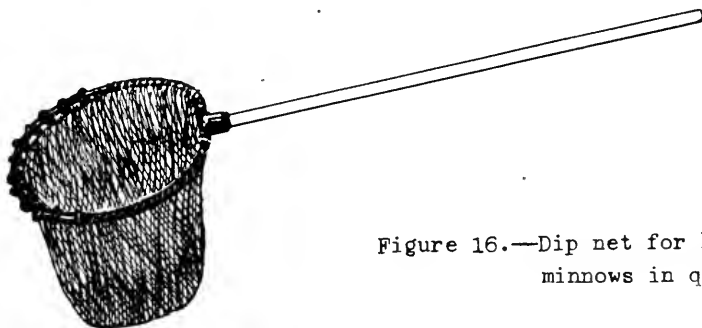

Figure 16.—Dip net for handling minnows in quantity.

Figure 17.—Scap net for use around the hatchery.



#### USE OF SCAPS OR HAND NETS

A scap net is very useful in the handling, sorting, and transfer of fish. Generally, the scap net is small, from 6 inches to 1 foot square, or not more than 8 to 10 inches in diameter if round. The netting material is supported by a rigid framework attached to a wooden handle. These nets usually have shallow pockets. The netting material is of small mesh and soft in texture so as to prevent injury to the fish being handled (fig. 17).

#### CARE OF COLLECTING GEAR

Nets should be carefully inspected for holes, repaired when holes appear, and thoroughly dried after each use. Stored nets should be kept in a cool dry place with a good circulation of air. If they are frequently used in waters rich in organic matter, it is well to have the nets treated occasionally with a preservative, such as tannin or copper oleate. It is not desirable to use tar as a preservative for minnow nets because this substance has a tendency to harden the fibres and thus introduce conditions which may be injurious to the fish being handled. Small hand nets, such as dip nets and scap nets, used daily in and about a bait dealer's establishment, should be kept (when not in use) in a sterilization bath consisting of a weak chlorine solution. In this way, disease organisms present will not be scattered from one tank to another. One formula used in Michigan hatcheries consists of 26 fluid ounces of cleanser (3 percent available chlorine) to 30 gallons of water. As chlorinated solutions deteriorate rapidly in the presence of organic materials or when exposed to air, the bath must be strengthened about once a week by adding 13 ounces of cleanser; once a month the entire solution should be discarded and a new bath prepared. A word of caution: chlorine is toxic to fish and discretion should be used when disposing of old sterilizing solutions.

## AERATION AND TEMPERATURE CONTROL IN TANKS

Aeration and temperature control are important in the operation of carrying and holding tanks. A series of experiments was run in Minnesota to determine the effect of these factors on the mortality of fish. It was shown that fat-headed minnows exposed over a period of hours to non-aerated waters die with increasing rapidity as higher temperatures are used. The most rapid loss occurs at temperatures above 65° F. Fat-headed minnows can be kept in well-aerated water for several hours at relatively high temperatures without loss, and greater numbers of minnows can be carried at all temperatures in aerated water than in non-aerated water.

These experiments showed that safe operation of minnow tanks requires close adherence to the following limits:

a. Water in non-aerated tanks should be kept at 65° F. or lower.

b. When tanks are aerated with running water, a continuous flow of not less than 1 gallon per minute for each 25 gallons of water in the tank should be maintained. The water should reach the tank from pressure jets placed well above the water level. Each tank should have a minimum of two pressure jets and at least one jet for every 25 gallons of water in the tank.

c. When oxygen is used for aeration, it should be dispersed into the water through carbonyl tips or a perforated oxygen-release tube. When oxygen or other forms of aeration are used, the equipment should be operated so as to maintain a minimum of three parts per million of dissolved oxygen under operating conditions.

d. A popular practice when handling minnows is to fill the truck tank at the bait store with cold water (often around 50° F.). While this water is hauled to the pond, it does not have time to warm up very much. The minnows are seined from a warm-water pond and placed in the cold water of the tank with only a few minutes of tempering. The shock is not great enough to kill the fish at once, but within several hours a large percentage will be dead. A minnow should not be subjected to more than a 10° change of temperature unless the change is very gradual. Proper tempering requires 20 minutes for every 10° change. A pocket

thermometer should be used to determine temperature differences.

Minnows that are to be used locally should not be held in very cold water. Unless the fisherman travels far enough for the water to warm up, the minnows will turn belly up when placed in the warm lake water.

#### TRANSPORTING MINNOWS

The hauling of minnows over long distances during very hot weather presents a difficult problem. Success depends on close adherence to sound methods. The following list includes some important requirements.

a. Conditions such as crowding, excessive handling and changing water temperatures encountered when transporting minnows for long distances, often prove fatal to many of the fish. As a means of reducing this loss, a 24-hour "hardening" process has been practiced. The fish to be transported are collected and placed into a tank where the water temperature can gradually be reduced until it is between 50° and 60° F. The fish are left in this bath for about 24 hours for conditioning. At the end of this period, they are transferred to transporting tanks that contain water of the same temperature and are ready for moving. People who use this technique claim that the fish will not only stand the trip better but will tolerate more handling and crowding than before.

b. To prevent injury to the fish, the wooden sides of the tank should be smooth. The tank should be large enough so that on rough roads the fish will not be dashed against the sides. Several sizes of tanks have proved satisfactory. One popular type is a single-compartment tank, 4 feet square and 3 feet deep, aerated with oxygen dispersed through a perforated release tube. This tank will carry 125 pounds of minnows for 300 or 400 miles with little or no loss. Another successful tank is 6 feet long, 3 feet wide, and 2½ feet deep. This tank is divided into two compartments, each of which will hold 100 pounds of minnows. It has the advantage of permitting the dealer to sort his fish either by species or by size when necessary (fig. 18).

c. Carrying tanks must be well aerated either by the application of oxygen or by pumping the water through pressure jets. Any system used should be able to maintain a minimum of three parts per million of

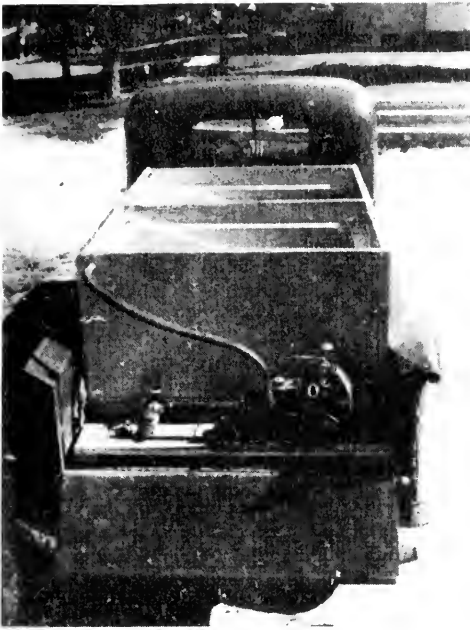

Figure 18.

—An inexpensive fish distribution tank.

dissolved oxygen for the duration of the trip under full load.

d. When the trip is unusually long and the weather extremely hot, the temperature should be maintained between  $65^{\circ}$  and  $70^{\circ}$  F. by periodic icing. When possible, long hauls should be made on cool days. Tanks that are constantly used for long hauls should be insulated with 4 inches of cork.

e. Salt is a tonic for fish and can be used to help them over the rigors of transportation. A salt bath should be given after the trip. When the aeration equipment consists of a pump and water jets, salt should not be used in the tank because sodium chloride rusts the equipment.

#### OPERATION OF THE HOLDING TANK

The loss of minnows from handling and holding operations is most evident in the holding tank. Though much of the loss is attributed to fungus disease, the largest part is the direct result of rough handling and careless operation of the holding tank. The following suggestions will help eliminate this mortality.

a. Holding tanks should be constructed of wood or smooth concrete and painted heavily, with asphaltum paint. Smooth sides in the tank help prevent disease and injury to the fish. The tank should be deep enough so that the fish are not injured by the jets of water

used for aeration. The bottom should slope slightly toward the outlet to facilitate cleaning and draining.

b. Each tank should be supplied with plenty of filtered water—spring water is filtered—and each tank should drain directly to the sewer without passing through other tanks. The water should enter the tank through pressure jets placed well above the surface of the water. One overflow outlet should be at or near the bottom to remove stagnant water and waste material.

c. The tank should be supplied with minnows that are in good physical condition. Minnows that are carefully seined, sorted in floating live boxes, slowly tempered, and transported in adequate equipment will live in the holding tank for a much longer time than those that have not received good treatment.

d. Each tank should be small enough so that the complete contents can be sold in a few days. No more fish should be added until these are sold, and the tank should never be overloaded. The transfer of fish from one tank to another will greatly aid the spread of disease.

e. When the fish from one tank have been sold, the tank should be drained and carefully cleaned. The sides and bottom should be thoroughly scrubbed with a 1:10,000 solution of sodium hypochlorite. This solution is mixed by adding 1 quart of sodium hypochlorite or 3 to 5 quarts of any commercial bleach to 250 gallons of water. The tank should be thoroughly sterilized at least once a week. After an ample rinse the tank can be filled with water and stocked with fish.

f. All dead fish in the tanks should be removed immediately and destroyed.

g. There may be considerable loss from the common practice of selling minnows wholesale by the gallon. This procedure necessitates the measuring of minnows in a nearly dry state. Such measuring cannot be done without injury to the fish. Hatcherymen usually weigh fish by first filling a metal basket half full of water, weighing the basket and water, and then adding the fish and reweighing. The difference in weight is the weight of the fish. By counting the number of fish in a pound, it is possible to determine the number of fish sold. With this method it is possible to wholesale fish by numbers, pounds, or gallons, allowing 8 pounds to the gallon. There is very little injury to the fish during weighing.

h. Very large dip nets should not be used for minnows. Lifting a half bushel of minnows in a dip



net is apt to injure those on the bottom. Overloading smaller nets will also produce injury and consequent loss of fish.

#### DISEASE CONTROL IN TANKS

Epidemics of fungus disease will produce a large loss of fish in holding tanks. While careful seining, transportation, and holding of the minnows will greatly reduce the chances of an epidemic starting, it may happen even in the best-regulated establishments.

At the start of the epidemic all dead fish should be removed and destroyed at once. The remaining fish should be dipped in malachite green 1:15,000 solution (1/8 ounce in 15 gallons of water) for 10 seconds. The tank must be drained and sterilized with sodium hypochlorite 1:10,000 solution. All tools and dippers must be sterilized in the same solution and must be re-sterilized daily until the epidemic is over.

Infected minnows should not be purchased or seined, as the danger from loss and spread of disease to healthy fish is too great. During times of scarcity when only infected minnows are available, the fish should be dipped for 10 seconds in a 1:15,000 solution of malachite green before being placed in the holding or tempering tanks. The malachite green should be discarded after 100 pounds of minnows have been treated or at the end of the day.

#### FEEDING MINNOWS IN TANKS

Minnows that are held for more than a few days must be fed. A series of feeding experiments conducted by the Wisconsin Fish Management Division to determine the effect of food on the loss of minnows in holding tanks, showed that brassy minnows could be held for 63 days at 46° F. with very little loss of weight when fed all the canned carp they could clean up. Fish that received no food succumbed to heavy infestations of fungus, but those receiving food had very little fungus. Fish that received half as much carp survived nearly as well and showed only slightly more loss of weight.

Minnows will eat a variety of foods, but the most practical are those that are easy to handle and convenient to store. The food should appeal to the fish so that it is consumed fast enough to prevent undue contamination of the tank water. Oatmeal and cottonseed meal are satisfactory foods. Meal worms, flour-

weevil larvae, and similar worms are very attractive to minnows and form a substantial food; but all must be raised for the purpose. As this takes quite a bit of time and space, most bait dealers do not use these organisms.

#### EGG-BOUND FISH

When men of the Wisconsin Fish Management Division were conducting the feeding experiment with brassy minnows, they noticed that there was an increased mortality during May and June. Post-mortem examination revealed that the majority were gravid, egg-bound females. The fact that they were ready to lay eggs but could not because of the cold water was interpreted as the cause of their deaths. This may account for part of the heavy loss of minnows in cold-water holding tanks during the warm summer months.

Adherence to the suggestions in this section will keep minnow losses to a minimum. The reduction of these losses will not only conserve minnows but will increase the profit to the bait dealer.

#### Source of materials and equipment

The man starting a new bait business is always confronted with the problem of obtaining necessary supplies and equipment. No fancy items are needed for the hatching, rearing, and transporting of minnows, but the bait dealer should obtain the best equipment available. Because of the great variation in prices and availability of equipment, no list of supplies can be included in the bulletin. Those interested in such information should write to the conservation department of the State where the business will be located.

### EARTHWORMS, CRAYFISH, AND CRICKETS

The bait dealer often has call for earthworms, soft crayfish, and crickets. These baits cannot be easily obtained in large enough quantities to supply the trade, but all can be raised in large quantities in a relatively short time.

#### Earthworms

Earthworms can be raised in basements, under heavy shade of trees, or in other cool places. Bait-size

worms can be had in 3 months, and the worms mature in 6 months. A tub 2 feet in diameter and 10 inches deep, fully utilized, should produce several thousand bait-size worms a year.

The different species of earthworms vary in size when full grown. The common earthworm or night crawler reaches a length of 10 inches; the small red species found in manure piles grows only to 3½ inches. The earthworm reared should be of a size suited to the fishing needs of the region.

A suitable soil is prepared by mixing manure, screened top soil, and peat moss into a fine loam. The peat moss may be replaced by other forms of organic matter such as leaves and hay. Another soil formula calls for dry coffee grounds and loam mixed 50-50. The loam should be well moistened but not soaking wet.

Almost any type of box is suitable for the culture of earthworms, but small boxes that can be handled easily are to be preferred. The lug boxes in which fruit is sold are excellent. An old tub or a metal drum cut lengthwise is also good. If wooden lugs are used, they should be placed on bricks or blocks to prevent the worms from escaping into the ground. Lugs can be stacked if separated by blocks.

When preparing the culture box, it is advisable to place a piece of burlap on the bottom, fill the box with prepared loam to a depth of 8 inches, smooth over the surface, and spread the breeder worms on top. After the worms have burrowed into the soil, the surface should be covered with burlap and moistened. The box will require water at frequent intervals to keep the soil moist.

The worms can be fed chicken mash or a mixture of coffee grounds, dried cracked wheat, and bread crumbs. Feed should be given daily. Another feeding formula is 1 pound of lard mixed with 2 pounds of corn meal. This should last a month. Ground garbage spread over the surface of the soil makes a good inexpensive food. Care should be taken that the food is in a thin layer or it may heat and destroy the worms.

The worms can be harvested by emptying the box and sorting out those of suitable size. The loam should be saved and transferred to a fresh box, as it contains the egg capsules which will start a new colony. The unused worms should be returned to the old box as breeders. Egg capsules for starting new boxes can be best obtained by covering the surface of the soil of a breeder box with a mulch of finely crushed dead leaves.

If this mulch is kept moist for several weeks, egg capsules will be laid here and will hatch in 14 to 21 days. The mulch and the soil immediately below can be added to new soil to start more boxes.

Before sale, the worms should be placed in sphagnum moss to "scour" for 3 or 4 days. At the end of this time the worms will be almost transparent but tough and lively. If it is necessary to leave them a week or longer in the moss, a little fresh milk should be poured over them at intervals of a week. The moss should be rinsed every 10 days. A good way to carry the worms on the lake is to place them in a sugar-sack full of damp moss. The sack should be dampened whenever necessary during the day.

### Crayfish

The comments of Markus (1939) may be helpful to those who are interested in the propagation of crayfish.

The crayfish, especially the soft-shelled individual, is very popular among anglers as a bait. ... Crayfish will propagate naturally in a pond and they may be produced in the same pond with minnows. The shallow end of a pond in which crayfish are propagated should have a sandy, inclined slope running in depth from zero at its edge to a depth of 6 inches about 15 feet out in the pond. Here the young crayfish may be found during the night and early morning. This shallow water also makes a convenient place to seine for them. This is especially true of that species of crayfish known as *Cambarus virilis*.

Crayfish mate in the early fall. The breeders should be placed in a pond during August for production the next year. Spawning usually occurs in the springtime and mating in the fall, although both may occur during the winter. Eggs may often be found in the late fall. The eggs resemble a bunch of berries and are carried by the female underneath her abdomen, attached to her swimmeret appendages. They are so carried until they hatch. As soon as the eggs hatch, the young cling to the mother's swimmerets and remain with her until they can shift for themselves. The number of eggs carried by a female depends upon her size. Langlois (Bull. 137) finds that the average number of eggs carried by a 44-mm. (1-3/4 inch) female is 80, while a 102-mm. (4 inch) female carries 374. The eggs are of a dark color and about the size of BB shot.

Crayfish may be taken from natural waters such as swamps, lakes, rivers, creeks, and streams. They feed on aquatic vegetation and decaying vegetable and animal matter. They also attack living animal life if it is not fast enough to keep out of their way.

All crayfish go through several soft-shell stages. Their outside shell is a chitinous skeleton to which their muscles are attached. The shell does not grow with the body so the crayfish sheds his outer shell and grows a larger one. As soon as he sheds the outer shell he becomes soft-shelled until the new one becomes hard. The crayfish that hatch in the spring molt, or shed their shell a number of times the first summer. So a greater number of soft-shelled individuals may be found among this group. These medium-sized individuals are preferred by anglers.

There is but one satisfactory method of making hard-shelled crayfish soft-shelled. That is by feeding them and developing growth, causing the crayfish to shed the old shell frequently. When a bait dealer propagates his own crayfish for bait, he may sort out the soft-shelled crayfish from his pond every 2 or 3 days and have soft-shelled individuals on hand continually during the summer. These individuals may be kept soft for a week or more by keeping them on ice. If they are kept cold, metabolism will slow up and growth will be retarded, with the result that the shell will not harden very fast. ... When they are removed from this cold storage to warmer quarters, it is best to do so gradually. They must be used soon after they are removed from cold storage, for the shell often hardens very rapidly after they warm up and become active. ...

Fishermen should keep ice, covered with moss, in the bottom of the soft-shelled crayfish container.

Langlois (1937) reports the following growth for crayfish (*Cambarus rusticus*) from Ohio ponds:

<u>Date</u>	<u>Length in inches</u>
May 15 . . . .	1/4
June 8 . . . .	3/4
June 21. . . .	1-1/8
July 14. . . .	1-7/16
August 18. . .	1-11/16
October 30 . .	2-3/8

### Crickets

Crickets can be raised in garbage cans placed in garages or other warm locations. The can should be waxed about 3 inches down from the top to keep the crickets from escaping. A layer of clean sand is placed in the can and kept moist to provide a place for crickets to lay their eggs. The sand is covered with wood excelsior to provide cover and perching space. Poultry laying mash is recommended as food, but when it

is not available, uncooked oatmeal is suitable. The food should be placed in a small pan or saucer. The production of 100 crickets will require about 2 pounds of mash. A quart fruit-jar drinking fountain of the type used for baby chicks is used to provide water. Cotton should be placed in the pan to keep the young crickets from drowning.

A garbage can should be stocked with 30 adult crickets, half males and half females. A female can be distinguished by the long egg-laying tube at the rear end of the abdomen. The can should be kept at a temperature of 80° to 90° F. because crickets grow faster at that temperature. A light bulb suspended into the can will help maintain the temperature during the cold weather. A can 24 inches in diameter can produce 400 crickets in 3 months. Crickets will not lay eggs until they have become adults. The adults can be recognized by the presence of wings; the young are wingless.

All dead crickets should be removed from the can, as they may be diseased or parasitized. The floor around the can should be dusted with insect powder to keep out ants, which kill crickets. Care must be taken to keep the dust from getting into the can. If the crickets are kept in an open building, the can must be screened to keep out parasites and spiders.

After one or two crops of crickets have been raised in a can, it should be thoroughly cleaned for a new start. This extra work will result in larger crops.

## LEECHES AND INSECT LARVAE

### Leeches

Leeches are predatory or parasitic annelid worms with terminal suckers serving for attachment and locomotion. They abound in ditches, pools, ponds, and lakes; and a few species occur in swift, cold streams. In small lakes of our northern borders, leeches fairly swarm. Some leeches are predatory hunters, and others are scavengers, but many change from one mode of feeding to another.

Leeches can be collected in traps baited with fresh coagulated blood. They may be taken by searching locations or by stirring the mud with one's bare feet and removing them from the skin as they become attached.

## May fly nymphs or wigglers

Nymphs of the burrowing May flies, usually known as "wigglers" to most bait dealers and fishermen, are one of the favorite and most important baits used in Michigan ice-fishing for panfish. Just what these "wigglers" are or something of their life history is not usually known by the men who collect and sell them or use them as bait.

The "wiggler" is the nymph or immature stage of an insect, the burrowing May fly. The nymphs (wigglers) live in the bottom mud of many of the lakes and streams. They are rather long slender creatures with a well-developed head, thorax, and abdomen. The head has two large eyes and a pair of long pointed tusks extending forward. The three pairs of legs are broad and flattened for digging. Along the abdomen are six pairs of large bushy gills, and at the tip of the abdomen are three fuzzy "tails." Though there are several kinds of burrowing May flies, they are similar in general appearance and habits. The body length of the grown nymphs ranges from  $3/4$  to  $1-3/8$  inches, the length varying with the sex and species. Only the larger nymphs are big enough to be collected and used as bait.

When the nymphs have become fully developed (in spring or early summer), they leave the bottom mud and swim and float to the surface. Here the skin of the nymph splits along the back and an adult May fly emerges and flies away to the nearest resting place. These adult burrowing May flies live but a few days, just long enough to lay their eggs. The adults, called fish flies, shad flies, and May flies, are often seen in great swarms, particularly around lights in regions where they are abundant.

The length of the life cycle, from the time the egg is hatched till the adult emerges, is not positively known but is probably 2 years. During this time the nymphs live in U-shaped burrows in the bottom mud. The burrow is open at both ends, and the nymph keeps a current of water flowing through the burrow by means of the action of its gills. The openings of these burrows, about as large as a pencil, can often be seen in shallow water in those lakes where they are abundant. Though these nymphs have been found in water from 1 to 40 feet in depth, most of them probably will be found in water from 2 to 10 feet in depth. The kind of bottom is extremely important to these nymphs, as they must be able to dig into it and maintain a burrow. If it is too

hard or too soft, they cannot burrow successfully. The differences in the type of bottom found in our different lakes probably explains why the nymphs are found in some lakes and not in others, also why they may occur in one part of a lake but not in other parts. A firm muck or soft marl bottom is usually best suited to the needs of the nymphs. They are not usually found in sand or gravel, in hard marl, in very soft, flocculent muck, or in peat bottoms. They are found in greater numbers (provided that the bottom material is suitable) where the bottom is quite bare and has only sparse vegetation. In streams the nymphs will be found in eddies, back-washes, and silt bars where the mud is of the right consistency for successful burrowing.

Successful digging of wigglers can be carried on through the ice in water up to about 10 feet in depth. Usually hand-operated, long-handled dip nets made of 1/8- to 1/4-inch mesh grit screen are used. A portion of the bottom is dipped up through a hole previously cut and is then washed or "puddled" by jiggling the net up and down in the water. The bottom material works through the screen mesh and exposes the wigglers for hand picking. Other devices, such as rockers, are used to wash larger quantities of the bottom material.

Nymphs of many different sizes will be found in a sample of mud from a bottom they are using. As only the large ones are usable as bait, care should be taken to return small nymphs to the water unharmed so that the stock of May flies will be maintained.

Proper care is necessary after the nymphs have been collected if they are to be kept successfully over a period of time. They must be kept in water having a good supply of oxygen at all times. As the nymphs seek to avoid light and always try to dig into the bottom or crawl under something, it is well to cover them with a layer of burlap, under which moss or *Chara* has been placed, to give them some protection. If they are kept in an open tank, they will swim continually until they are exhausted and will not survive long.

### Hellgrammite

The hellgrammite is the larval form of the dobson fly. The larvae are found under rocks in the fast water of streams, where they live for 3 years before emerging as adults. They feed on May flies, stone flies, and other aquatic insect larvae. The hellgrammite is easily recognized by the presence of slender,



fleshy appendages along the abdomen, one pair on each segment.

Hellgrammites are excellent bass bait and are tenacious of life. The larvae may be kept in running water or in a bucket of damp leaves. When kept for more than a few days, they should be fed ground meat. Because of cannibalism they cannot be crowded in holding buckets.

The larvae can be collected by placing a fine-mesh net in the streams, turning over the stones immediately upstream, and allowing the current to wash the insects into the net. When used for bait, they can best be carried in damp moss and it is advisable to hook them through the skin at the middle of the back.

### Caddis fly larvae

The larvae of caddis flies are found in fresh water, both streams and ponds. The adults resemble moths but differ in having hair instead of scales on their wings and in lacking the long, curled-up proboscis of moths.

The larvae in the water resemble moth caterpillars but are almost always characterized by possession of a protective case which they fabricate from sand, bits of leaves, or tiny twigs. Larvae of the larger species, especially those normally occurring in slow streams or along lake and pond shores, are much used as bait. As many different species may be used, no accurate description can be given. All the bait species make tubular cases. Many have threadlike gills along the sides of the abdomen, and all have a pair of short, curved, horny hooks at the end of the abdomen, apparently to anchor them to their cases. All have six legs, with which they drag their case-laden bodies over the bottom. The species popular as bait are most numerous in beds of vegetation, especially water cress and cattails.

Most female caddis flies lay their eggs during the summer, always under water and often in gelatinous masses which may be affixed to submerged stones or twisted around aquatic vegetation. The eggs hatch in a few weeks, and the larvae spend the winter feeding and growing underwater. Generally the pupae are formed in late winter and adults commence emerging in early spring. Adults of a few species emerge on warm days throughout the winter.

Some of the larvae most popular as bait are highly carnivorous and will eat each other if confined together.

in close quarters. Other species feed either on very minute animal organisms or on vegetable matter. The larvae of species commonly used as bait range between 1/2 and 1-1/4 inches in length. Much harm can be done to streams by bait seekers who drag large quantities of aquatic vegetation onto the bank to collect these larvae.

### European corn borer

The corn borer, a serious pest introduced from Europe about 1910, is a brownish moth with a 1-inch wingspread. The larva, which is used as fish bait, is a typical wormlike caterpillar that attains a length of 3/4 to 1 inch. Pale yellowish-white to flesh color, it has an indistinct stripe down the middle of the back, a row of small, round, brown dots on either side.

Eggs are laid throughout the summer on the under sides of growing corn leaves. A female may lay more than 600 eggs in small groups. The eggs hatch in about a week. Until half grown, the larvae feed between leaves, under husks, in tassels, or elsewhere on the exterior; then they burrow inside the stalk, the ear, or the thicker parts of the leaves. The larvae live through the winter, generally embedded in the stalk just above the ground. The cocoon is spun in the spring and adults start emerging early in summer.

In the Tri-State area there is but one generation yearly, and corn is the predominant food. In the eastern States there are two generations, and the borer attacks a wide range of garden and farm crops, flowers, and weeds.

Corn-borer larvae can be collected from late fall until early spring. They offer excellent bait for winter bluegill fishing.

### Catalpa worm

The catalpa worm is the larva of a sphinx or hawk moth that is a serious pest of catalpa trees, which form its only food. The larva or caterpillar attains a length of 3 inches, is smooth, dark brown or black above and dark green on the sides, and has a short, sharp, thornlike horn at the tip of the abdomen.

The white eggs are deposited on the under side of catalpa leaves soon after these appear. As many as 1,000 may appear in a single mass. The eggs hatch in about 2 weeks. The larvae feed until full grown, then

migrate down the tree trunk and pupate in loose soil. There may be two generations a year. The first crop of larvae generally appears in May, the second in August or September. The insect winters in the pupal stage. The catalpa worm is good bluegill bait for late summer.

### White grubs

White grubs are the larvae of June beetles. They are very destructive pests, especially damaging to grass and grain. It is hard to find a single cultivated plant that may not be attacked by these grubs.

White grubs commonly collected and used as bait are fat-bodied, brown-headed grubs from 1/2 to 1 inch in length. Because the body contents show through the shiny, semitransparent body wall, the white body shades into bluish black at the posterior end.

Eggs are laid during spring and summer, generally from 1 to 3 inches below the surface of the soil. Two winters are spent in the larval or grub stage, the grub feeding on roots, especially of grasses during the warmer months, and migrating downward to a depth of as much as 5 feet during the winter. Transformation to the adult beetle stage takes place late in summer. These adults, however, do not leave the soil until the following spring. Although the 3-year cycle just described is the most common, some species require as little as 1 year, others as long as 4.

There are other white grubs which closely resemble the grass-root feeders but which occur in manure and rotting vegetation and do not feed on living plant material. They can be found in suitable quantities in heavy old-sodded ground overlying black dirt or in rich soil.

### Goldenrod gall worms

The goldenrod gall worm or maggot is the larva of a small fly with spotted wings. The maggot burrows into the stem of the goldenrod plant, which then forms the gall, apparently as a matter of self-protection. The fly is abundant, and in many goldenrod patches more than half of the stalks will be seen to bear galls.

The larva is very small, seldom 1/4 inch long. It is white or faintly yellowish, soft-bodied, without visible legs. Eggs are laid early in summer. The larva hibernates in the gall, pupates, and emerges as an adult

in late spring or early summer. The gall worm is a winter bluegill bait.

### Wood borers

Two types of wood-boring beetle larvae are occasionally used as fish bait. One, the flat-headed borer which makes a burrow that is oval in cross-section, is the larva of the metallic wood-borer beetle. The other, the round-headed borer, which makes a burrow round in cross-section, is the larva of the long-horned beetle.

The female flat-headed borer lays her eggs in bark crevices or injuries on a wide variety of shade, forest, and orchard trees. The larva grows rapidly, feeding first just under the bark, later burrowing into the wood to the depth of an inch or more. When mature, the larva is between 1 and 1½ inches in length, pale yellow except for a dark head, and shows a curious widening and flattening of a few body segments just behind the head. There is one generation yearly; adult females lay eggs throughout the summer. There are many species and a wide range of size. The species just described is typical and is the one most often used as fish bait.

Many species of round-headed borers exist. A typical life history follows: eggs are laid throughout summer in bark crevices on tree trunks, from a few inches below the soil to several feet above it; larvae require 2 years to develop, during which time they burrow through the wood to a depth of 1 or 2 inches. The full-grown larva is from 1 to 1½ inches long, has a yellow body and a dark-brown head.

Wood borers are winter bluegill bait and can be obtained from rotten wood, especially dead trees.

## LIFE HISTORIES OF IMPORTANT BAIT FISHES

Maximum production of minnows in ponds can be achieved through knowledge of the life history of each species being propagated. This knowledge aids in the selection of the species for each pond, in the choice of spawning facilities to be supplied, and in determining the amount and kind of fertilization to be used.

Fish, like most animals, have definite food preferences. Many feed entirely on tiny drifting plants, others feed on animals, and some feed on both. Some eat only small drifting plankton, others prefer insects, and some take whatever comes along. Food

Table 11. --Summary percentages of food volume found in digestive tracts of certain bait species 1/

Bait species	Food items																	
	Insects	Mollusks	Fish	Annelids	Crayfish	Crustaceans	Amphipods	Arachnids	Plants	Algae and plants	Algae and diatoms	Plankton	Zooplankton	Phytoplankton	Bryozoans ( <i>Plumatella</i> )	Surface drift	Miscellaneous foods	Sand, silt, and debris
Golden shiner	35.0	1.9	-	-	-	12.0	0.4	1.4	5.3	13.3	-	23.6	-	-	1.4	-	0.2	-
Fat-headed and blunt-nosed minnow	15.9	-	-	0.5	-	5.5	-	-	9.7	-	4.9	-	6.9	35.0	-	10.8	-	11.3
Mud minnow	45.3	12.3	-	-	-	16.3	11.1	0.13	7.1	-	1.4	-	-	-	-	4.6	1.24	0.2
Common shiner	37.2	-	7.1	-	-	-	-	-	39.9	-	-	11.3	-	-	-	26.0	2.9	1.1
Creek chub	51.3	3.0	5.4	2.1	3.0	0.8	-	-	4.6	-	2.3	-	-	-	-	2.1	1.0	-
Common sucker	39.0	10.3	-	-	-	3.3	-	-	3.7	-	-	26.3	-	-	0.5	-	8.3	-
Horny-headed chub	75.0	-	-	-	5.6	-	-	-	-	-	13.9	-	-	-	-	-	-	5.6
Lake emerald shiner	40.3	-	-	-	-	37.5	-	-	-	-	7.9	-	-	-	-	-	6.1	-
Spotfin shiner	83.4	-	-	-	-	-	-	-	-	-	-	-	-	-	-	-	11.5	-
Brassy minnow	21.3	-	-	-	-	-	-	-	3.4	-	-	-	25.9	31.6	-	16.1	-	1.7
Stone roller	10.0	-	-	-	-	-	-	-	-	-	60.0	-	-	-	-	-	-	30.0

1/ Based on studies referred to under each species.

Table 12. ---Summary of breeding requirements of species considered most suitable for bait

Species	Breeding habitat							Breeding conditions							Deposition of eggs						Eggs cared for by	Probable breeding season							
	Brooks	Creeks	Rivers	Lakes	Ponds	Forested swamp	Open swamp or marsh	(Under 3 ft.)	Shallow water	In or near riffles	Stream pool	Rapid current	Single bottom	Gavel bottom	Water plants	On bottom stones	On water plants	On unprepared bottom	In depression nest	In pebble-heap nest		On boards and tin articles	March	Apr 1	May	June	July	August	
Fine-scaled dace	x					x																							
Red-bellied dace																													
Golden shiner																													
Fat-headed minnow																													
Blunt-nosed minnow																													
Mud minnow																													
Common shiner																													
Creek chub																													
Common sucker																													
Horny-headed chub																													
Lake emerald shiner																													
Spotfin shiner																													
Brassy minnow																													
Stone roller																													

preferences of a fish usually vary with its age. The young can swallow only small organisms and therefore feed mostly on plankton. Adults require larger and more substantial food. For maximum production in ponds, minnows should be provided with the foods most suited to their needs and their ages. Choice of pond and fertilization can greatly affect the type and availability of food. Table 11 presents a summary of the percentages of food items used by certain bait species, as examined in various studies.

Water temperatures have a direct effect on the amount of food eaten by a fish. In cold-water ponds the consumption of food is low and growth of the minnows is slow. Also, when the water becomes excessively hot, food consumption again declines and growth becomes slow.

Spawning requirements, like feeding habits, are different for different minnow species. Some require flowing waters; others do not. Some lay their eggs on vegetation; some lay their eggs on open gravel shoals or under debris. Some have extended spawning seasons and others have short ones. Adequate facilities for spawning are necessities in good pond management. Table 12 presents a summary of information regarding the breeding of certain bait species.

To comply with natural habitat requirements is important for some species. Those normally living in bog streams or swift currents might not be readily adapted for life in ponds or holding tanks. In general, however, most stream or lake minnows can be reared in ponds and with proper feeding may grow at faster rates than in their natural environment.

The name "minnow" is commonly but erroneously applied to small fishes of all species. The true minnows, however, are members of one family of freshwater fishes (Cyprinidae) and have definite characteristics that separate them from other families. Most minnows are small but some like the carp (an introduced minnow) and the western "white salmon" attain a weight of 40 to 80 pounds. Young specimens of game and food fishes such as perch minnows and pike minnows, which should be called fry or fingerlings, are often improperly called minnows. Most bait fishes are minnows, but some important species like the mud minnow and the sucker belong to other families.

Of the fishes that are used for bait, the true minnows are the most important group. Minnows of eastern and central North America can be distinguished from other fishes by the following characters: no teeth on the jaws; no scales on the head but covering remainder of body; no spiny rays in any of the fins (except in carp and goldfish); one dorsal fin; less than 10 rays in the dorsal fin (except carp and goldfish); pelvic fins abdominal in position; size usually small, under 6 inches (fig. 19).

There are many species of minnows, but the following pages include only the 15 species that are important as bait fishes.

Figure 19.—A typical minnow showing parts used in identification.

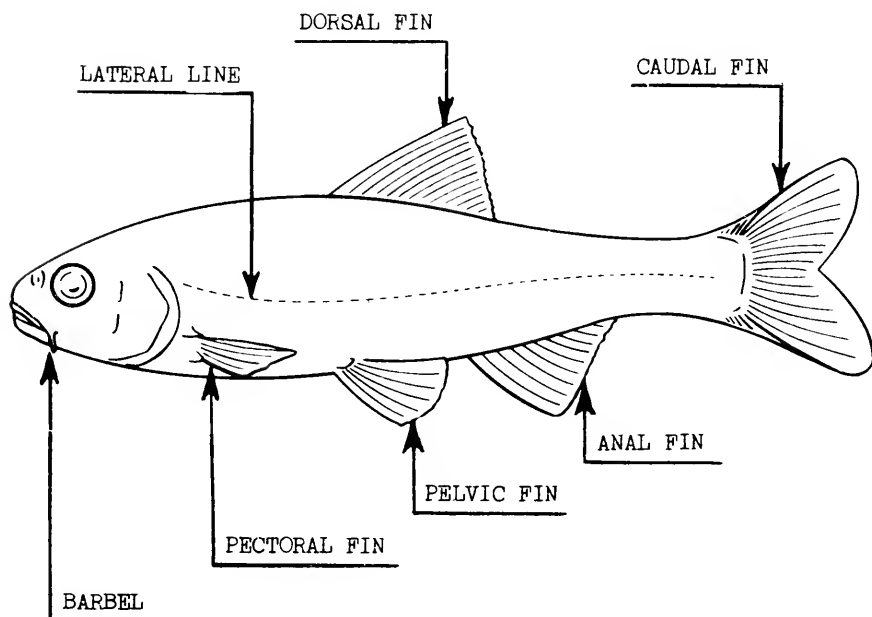





Northern creek chub

## Northern creek chub

*Semotilus a. atromaculatus* (Mitchell)

*General description.*—Black spot at base of dorsal fin; mouth large, extending back to below eye; small barbel hidden just above corners of mouth in groove behind under jaw; scales smaller and more crowded at front end of body; color, olive green on top, steel blue on sides, white on belly; size of females to 5 inches, males to 11 inches.

This minnow is found most often in creeks and rivers in the north, south, and central part of the United States. The chub is tenacious of life and considered excellent bait for both pike and panfish. Though it spawns in moving waters, it grows very well in ponds and in slow-moving streams. The creek chub spawns during April, May, and June in small creeks on gravel beds at the base of pools or at the head of riffles. The male prepares and guards the nest during the active period. The young fish make an excellent growth in the first year, reaching a length of  $3\frac{1}{2}$  inches by September. The creek chub is easily stripped of eggs and the number is relatively large. This fish is believed exceptionally suitable for production in large numbers in artificial ponds.

The northern creek chub seems to eat anything that comes its way. It has been known to feed on algae, vegetable matter, aquatic insects, terrestrial insects, crayfish, small fish, fish eggs, chub eggs, snails, and small mollusks, and it often rises to a trout lure. Sometimes a chub stomach will contain only surface drift. A study of 37 stomachs taken from fish collected in the East and Midwest showed the average percentage of the various food items to be as follows: insects, 51.3; mollusks, 3.0; crustaceans, 0.8; fishes, 5.4; crayfish, 3.0; annelids, 2.1; surface drift, 26.0; algae, 2.8; plants, 4.6; vegetable debris and plant seeds, 1.0.

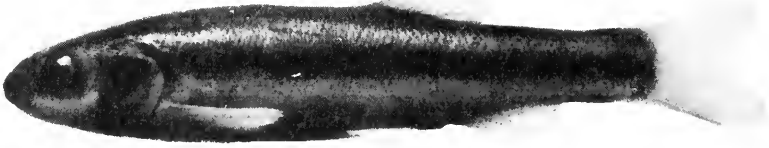

Northern pearl dace

## Northern pearl dace

*Margariscus margarita nachtriebi* (Cox)

*General description.*—Robust minnow; snout blunt and head rounded; small but visible scales; mouth not extended behind eye; color a dusky silver mottled by darker scales; no large nuptial tubercles, no black pigment spots on fins.

The pearl dace prefers cool lakes, bogs, and creeks. Its range is through all Canada east of the Rockies and northern United States to New York.

This species probably lays its eggs early in spring. The bright, red-sided breeding males are highly colored from early February until late spring. The red fades gradually from their sides until it is nearly gone in the fall.

This species is considered excellent bait. It withstands excessive crowding, water of low oxygen (0.02 p.p.m.) content, and warm temperature: 4 gallons of this species, together with fine-scaled dace (*Pfritille neogaea*), have been carried in a 5-gallon can for nearly 2 hours at a temperature of 40° F. without the loss of a single specimen. The northern pearl dace grows to a length of at least 3½ inches in 1 year, and reaches a maximum of 7 inches. It is possible that this species could be reared successfully in artificial ponds, and that bait sufficiently large for catching panfish could be raised in one summer. Because it makes a fine growth in northern boggy waters, this fish could be raised in northern areas in places where land is cheap. The food habits of the pearl dace have received little attention. From the studies available for this minnow it seems probable that insects are preferred, but the fish has been known to feed on phytoplankton, mollusks, surface drift, and watermites. For dealers with little working capital, this species, together with the fine-scaled dace, seems to offer excellent opportunities.

*Horney-headed chub*

### Horney-headed chub

*Nocomis biguttatus* (Kirtland)

*General description.*—Heavy robust minnow; blunt nose; large scales clearly outlined; large diffuse black spot at base of tail, tail-fin red in young; small barbels at corners of mouth; body color usually olivaceous; large tubercles on top of head and orange-red spot behind eye of breeding males.

The horny-headed chub is a minnow of large creeks and small rivers, preferring swift waters and gravel bottoms. It is found in the United States east of the Rockies to the Hudson River. It is an excellent bait fish, hardy on the hook or in storage tanks, and attains large size.

This chub spawns late in May and early in June on gravelly riffles in 1 to 2 feet of water at 65° F. or warmer. The nest is either a natural cavity in the stream bottom or one fanned out by the fish. Mating activities and stone-carrying into the nest by males are alternated so that the pebbles and eggs are mixed in the nest. The nest pile is large, often covering several square feet of bottom, and 2 to 6 inches deep. Each nest is occupied by a single male who probably spawns with several females. These nest piles are often used by common shiners at the same time, the males of both species guarding the nest. The male attains a maximum length of about 10 inches and the females are smaller. This minnow requires several years to reach maturity.

The food of the horny-headed chub is mostly insect larvae and crustaceans. A summary of several food studies made in New York showed an average percentage of the following food items: crayfish, 5.6; May flies, 11.1; caddis flies, 2.8; chironomid larvae and pupae, 29.4; miscellaneous insects, 7.8; small beetles, 23.9; algae, 13.9; and silt, 5.6.

## River chub

*Nocomis micropogon* (Cope)

*General description.*—Body robust, nose blunt, scales large and easily seen, similar to horny-headed chub (preceding); black spot at base of tail indistinct and of no definite shape; tail fin of young sometimes amber but not red; no red spot behind eye; several large tubercles on swollen forehead of breeding males.

The river chub, *Nocomis micropogon* (Cope), is found in southern Michigan and is used as a bait minnow there, but it is not found in Wisconsin or Minnesota. It differs from the horny-headed chub in having an indistinct black spot of no definite shape at the base of the tail, no red on the caudal fin, and in its preference for larger rivers.

Its life history is similar to that of the horny-headed chub. The river chub also frequents larger rivers from Michigan southward to Virginia and Alabama.

Excellent descriptions of breeding habits have been written by Michigan investigators. According to their observations, the male first digs a pit 12 to 15 inches in diameter and 3 to 6 inches deep in the stream bed in water less than 2 feet deep. Stones are removed by being carried away in the mouth. The male then fills the pit again with other stones until a heap of large pebbles, 30 inches across and 3 inches high, is accumulated; all in 2 to 5 days. Small "spawning troughs" are then made by the male in the surface of this stone pile to receive eggs and milt as they drop from the spawning fish above. The troughs are filled again with pebbles immediately after spawning. Common shiners, horny-headed chubs, and stone-roller minnows may use the stone pile for a spawning place at the same time.



*Western black-nosed dace*

### Western black-nosed dace

*Rhinichthys atratulus meleagris* (Agassiz)

*General description.*—Active, streamlined minnow, usually under 3 inches in length; color dusky or black above with pronounced freckles or dark spots over top and sides of body; black streak on side of body, extending forward through eye and snout; scales small but easily seen; small barbel clearly visible at each corner of mouth especially when mouth is opened; fins short and rounded; dorsal set behind pelvics; most abundant in small, cool streams; rarely taken from lakes or ponds.

This form is found in clear, rocky streams from New Brunswick to North Dakota and south to Iowa and Alabama.

The black-nosed dace spawns in April and May when the water temperature of the creek reaches about 75° F. The spawning site is located at the head of riffles. They frequently occupy the same riffles used by creek chubs—when the chubs are absent. Langlois (1941) comments on the spawning activities:

Each male occupies a "holding" though shifting around considerably. When a female enters a "holding" the male goes to her and sometimes passes several times around her before coming to a lateral parallel position for spawning. When side by side, the female vibrates her tail, sometimes nearly burying it while doing so, and at the same time the male's tail starts vibrating and curling up over the female's tail to her dorsal fin, when vibrations cease. Occasionally the pair remains in place and spawns again immediately, but usually they separate, the male darting forward while the female relaxes limply onto one side, remaining there sometimes for several seconds.

The milt and eggs may be stripped from ripe males and females, and artificial fertilization is practical. The eggs are about 1/16-inch in diameter when laid but quickly swell to about 1/8 of an inch.

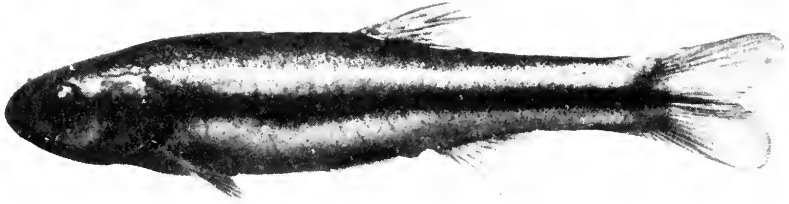
*Fine-scaled dace*

### Fine-scaled dace

*Pfrittle neogaea* (Cope)

*General description.*—Robust minnow growing to 5 inches in length; nose blunt, fins short and rounded; large terminal mouth, no barbels; very fine scales; color dark; one indistinct black lateral band on side of body; inner lining of body cavity black; intestine less than twice as long as body.

This species is most often found in cool, boggy creeks and ponds. Its range includes eastern Canada and northern parts of northeastern United States. The fine-scaled dace is tenacious of life and survives well in crowded containers. It reaches a size of 6 inches and is a satisfactory pike bait. Like the northern pearl dace, its bright red sides retain their brilliance most of the year but are most beautiful in late winter. It is possible that this species could be grown successfully in small boggy ponds, though little is known of its spawning habits or requirements.

The limited food studies conducted indicate that both phytoplankton and higher plants are preferred. In some stomachs, however, nearly half of the food has been insects, and the minnow is known to eat zooplankton and crustaceans to a limited extent.

### Northern red-bellied dace

*Chrosomus eos* (Cope)

*General description.*—Small minnows (3-inch); two dusky lateral bands from head to tail; dark bronze color except for silvery belly of females, scarlet in males; fins of breeding male red or yellow; scales unnoticeable; mouth small and pointing upward at end of snout; lining of body cavity black, intestine more than twice as long as body.



*Northern red-bellied dace*

Because they are so similar, no attempt is made to separate by characters the northern and southern red-bellied dace. Though their ranges slightly overlap, the bait dealer can best distinguish them by location of capture. The southern form is found in southeastern Minnesota, southern half of Wisconsin, and southern Michigan. The northern species is found throughout the remaining parts of these States, commonly in bog ponds and sluggish creeks. In Minnesota it seems to prefer acid-bog lakes; in Michigan, in addition to its occurrences in bog lakes, it has been found in small ponds showing a heavy growth of *Chara* and a rapid deposition of marl. Its range includes all our northeastern and north-central United States.

In the spawning season the males are brilliantly colored. The abdomen is a beautiful red and the fins are highly colored with red and yellow. The scales are minute and this species, together with the fine-scaled dace, has been called "leatherback" by sportsmen and minnow dealers.

The spawning habits, rate of growth, and age at maturity have been carefully studied in Michigan. The eggs are deposited entirely upon filamentous algae. One female lays from 5 to 30 non-adhesive eggs scattered through and entangled among the filaments. The female darts from one algal mass to another, laying eggs in each new mass. The eggs hatch in 8 to 10 days at water temperatures of 70° to 80° F. Spawning takes place from the latter part of May into August in southern Michigan.

Adult females revealed, when dissected, the simultaneous maturity of several hundred eggs and the presence of at least two size-groups of maturing eggs. This suggests that one female has no fewer than two distinct spawning periods during one season. The young, hatching early in the summer, attain nearly adult size by the end of the first growing season and

spawn early the next summer. Those hatching late in the season pass the first winter as small fish and require most of the next summer to reach maturity, often not spawning until their third summer.

The experimental propagation of this species in Michigan has shown that 128,000 fish can be raised per acre. The red-bellied dace is best suited to cool waters. This species does not reach a length of more than  $2\frac{1}{2}$  inches and is valuable as bait for panfish only.

Studies made in the St. Lawrence watershed of New York indicate that this species is mainly herbivorous, that it feeds almost entirely upon diatoms and other algae, on the remains of seed plants, and only to a limited degree on insects and animal plankton.

#### Southern red-bellied dace

##### *Chrosomus erythrogaster* (Rafinesque)

The southern red-bellied dace differs from the northern species in its more horizontal mouth, longer snout, and narrower caudal peduncle. It is more southern in range and has a decided preference for cool, gravelly creeks from southern Minnesota through southeastern Michigan into West Virginia, south to Oklahoma.

In Minnesota this dace is not so hardy as the northern species but is frequently used as bait in the southern part of the State.

Feeding and spawning habits are believed similar to those of the northern species. The major differences seem to be a preference for spawning on gravelly bottoms and selection of a more insectivorous diet.

#### Western golden shiner

##### *Notemigonus chrysoleucas auratus* (Rafinesque)

*General description.*—Body thin and flat from side to side, deep from top to bottom; adult golden in color, scales loose and easily visible; mouth small and upturned with no barbels; base of the anal fin long, containing many more than the customary 7 or 8 rays; dorsal fin far behind the pelvic fins; dorsal and anal fins sharply pointed; sharp ridge or keel on belly between pelvic and anal fins; lateral line curves downward and follows ventral body contour.





*Western golden shiner*

The golden shiner is widely distributed throughout eastern United States and westward to the Dakotas and Texas. The western form, *auratus*, is most common west of the Allegheny Mountains and north of Arkansas and is the only subspecies occurring in the Lake States. This species prefers lakes but is also common in the quiet sections of some of the larger rivers, frequenting densely vegetated bays and shoals.

The golden shiner has a long spawning season extending from June into August in Michigan and from early May to August in Minnesota. The eggs, which are adhesive and stick to plants, are commonly scattered over filamentous algae and less frequently over rooted aquatic plants. In Minnesota this shiner reaches a size for pike bait in the fall of its first year. The female grows faster and larger than the male. This species may mature in 1 year in warm regions at a length of  $2\frac{1}{2}$  inches, but in most of the Lake States it probably does not mature before the second year. Members of this species are known to have lived for 8 years. A maximum length of 10 inches has been reported. In Michigan and Iowa this species has been produced at a rate of more than 200,000 an acre in fertilized ponds.

The golden shiner is omnivorous. The young feed on algae and entomostracans. The adults have been known to eat young fishes, insects, plankton, crustaceans, protozoans, algae, diatoms, and mollusks. Some stomachs contain nothing but insects; some, nothing but plankton; others, 95 percent algae; a few had more than 75 percent amphipods; and three contained 5 percent arachnids. The food percentages in golden shiner stomachs examined by a number of workers are as follows: insects, 35.0; plankton, 28.5; algae, 13.8; plants, 5.3; amphipods, 0.4; mollusks, 1.9; arachnids, 1.4; bryozoans, 1.4; rotifers and protozoans, 0.2; and crustaceans, 12.0.

*Lake emerald shiner*

### Lake emerald shiner

*Notropis a. atherinoides* (Rafinesque)

*General description.*—Body thin and streamlined, snout blunt; scales silvery colored with no black pigment, loose and easily removed; mouth large with thin black lips running to tip of nose; dorsal fin behind point of pelvic fin attachment; anal fin pointed (as is dorsal) and containing about 9 rays.

The lake emerald shiner is found in large lakes and rivers, usually in large schools in open waters. Its range includes the larger glacial lakes in Hudson Bay, the Great Lakes drainages, and the larger tributaries of the Mississippi River.

The minnow spawns over gravel shoals from the middle of May to early June. The fish averages 1-3/4 inches at the end of the first year and 3 inches at the end of the second. It is often used for bait despite the fact that it dies quickly and its scales come off easily. It is a good bait for bass, perch, and wall-eyed pike. Hardy in cold weather, this fish is a favorite for winter fishing.

The food of the lake emerald shiner consists largely of insects, most of which are often terrestrial. This shiner has been known to feed on entomostracans, algae, small fish, fish eggs, terrestrial insects, aquatic insects, and oligochaete worms. The studies of several workers show that, in general, the food percentages are as follows: water fleas, 26.8; algae, 7.9; water boatmen, 1.0; May flies, 1.3; caddis flies, 2.1; chironomids, 9.7; terrestrial insects, 7.9; miscellaneous insects, 26.3; fish eggs, 2.9; crustacean debris, 10.7; and miscellaneous, 3.2.

*Northern common shiner*

### Northern common shiner

*Notropis cornutus frontalis* (Agassiz)

*General description.*—Color silvery on sides, white on belly when alive; scales large, high, and narrow on side of the body; no barbel; dorsal fin inserted directly over pelvics; size of 8 inches attained by males.

This minnow is common in nearly all cool creeks and lakes of northeastern United States. It is used widely for bait but is one of the less hardy species. It often grows to a length of 8 inches or more.

As far as is known, it spawns only on stream riffles over gravelly bottoms but its abundance in some inland lakes may mean that it is successful in spawning on gravel shoals in quiet waters. The spawning season is short in Michigan, extending from the latter part of May into June; it begins somewhat earlier in Minnesota's western waters. Studies in Michigan have shown that the common shiner grows about 2 inches the first year and requires 2 or 3 years to reach maturity.

Little or no success has been obtained in stripping the eggs from this fish. To raise this species, rearing ponds should be arranged to allow adult fish to swim upstream from the ponds to lay their eggs. The young will then drift downstream and grow in the ponds as do other species.

Only in the most recent food studies have the subspecies of this minnow been considered separately. Here the food habits of the northern *frontalis* and the southern *chrysocephalus* are considered together.

The common shiner is omnivorous in its feeding habits. It has been known to eat algae, insects, fish, plants, entomostracans, hydrachnids, protozoans, and desmids. Stomachs of this species have contained in some instances 100 percent insects; in others, 100 percent algae and plants. The studies of several

workers showed that, in general, the food percentages are as follows: insects, 37.2; algae and plants, 39.9; plankton, 11.8; fish, 7.1; sand and silt, 1.1; and miscellaneous foods, 2.9.



*Spotfin shiner*

### Spotfin shiner

*Aetropis spilopterus* (Cope)

*General description.*—Body thin from side to side, deep from top to bottom; dorsal fin with black pigment on one or two membranes between posterior rays; breeding males often steel-blue in color with orange fins and small pointed tubercles on snout; females and young fish silvery blue in color.

The spotfin shiner prefers rapid-running streams, but is sometimes found in clear, weedy lakes. It occurs from the eastern part of the Dakotas to New England, except in Lake Superior and its tributaries.

The spotfin shiner spawns from May to August on gravelly riffles or over sandy shoals. The adhesive eggs are often laid on logs and dock pilings, in crevices of submerged tree trunks, and even in old pails. The spotfin is a good bait species, active, hardy on the hook and in the live-box.

The food of this shiner consists mostly of insects. It has been known to eat both aquatic and terrestrial insects, small fishes, vegetable matter, small crustaceans, plankton, and carp eggs. Food studies by several workers show that, in general, the food percentages are as follows: midge larvae, 17.5; May fly nymphs, 6.2; miscellaneous insects, 64.7; and miscellaneous, 11.5.

*Brassy minnow***Brassy minnow***Hybognathus hankinsoni* (Hubbs)

*General description.*—Small minnow with large, easily removed scales; scales not small and crowded behind head; brassy sheen on sides of body; snout blunt and rounded, mouth small; fins short, rounded on tip, and free edges; lining of body cavity black, intestine (coiled like watch spring) more than twice as long as body.

One of the most common and widespread bait fishes of the Great Lakes region, ranging from Montana to the headwaters of the Hudson River in New York, and south in the western States to Kansas. This minnow is often found in small creeks, commonly in bog streams, and sometimes in lakes.

Little is known of its spawning habits, but adhesive eggs probably are scattered over bottom sand, mud, or debris early in the spring when water temperatures reach 50° to 55° F. Growth is slow and maturity probably is reached at the age of 2 years with a length of 2½ to 3 inches. Larger specimens may be raised in fertilized ponds.

The food of the brassy minnow is varied. A summary of food studies made by two workers indicates the following percentages: animal plankton, 25.9; plant plankton, 31.6; aquatic insects, 21.3; plants, 3.4; surface drift, 16.1; and silt, 1.7.

**Fat-headed minnow***Pimephales p. promelas* (Rafinesque)

*General description.*—First obvious ray of the dorsal fin thickened so that it stands out; mouth small, terminal, and upturned; scales small and crowded behind the head; back rounded and arched; lateral line only on anterior half of body; breeding male with black head;

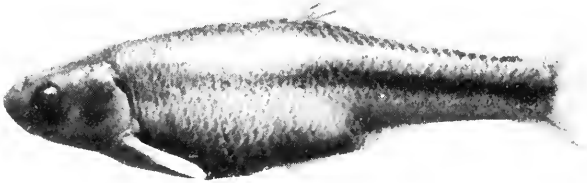
*Fat-headed minnow*

soft swollen pad on top of neck region; breeding tubercles on snout and under chin; lining of body cavity black; intestine two to three times body length.

This fish is generally distributed throughout southern Canada and northern United States. In Michigan and northern Wisconsin it frequents boggy lakes, ponds, and streams. In southern Wisconsin and in southern and western Minnesota, it is found commonly in small ponds and silty streams.

The males are larger than the females and reach a maximum length of  $3\frac{1}{2}$  inches. They bear pearl organs on their black heads and soft, swollen pads on their backs during the spawning season. The spawning season extends in some localities from May until the latter part of August. A temperature of about  $64^{\circ}$  F. seems necessary before spawning begins. The females may reach maturity and begin spawning the following spring at an age of 1 year. The eggs are deposited on the underside of many objects in a pond. Several females may deposit their eggs in a nesting site which is zealously guarded by one male. From 36 to 12,000 eggs have been deposited at one site in a circular or oval spot. A single female has yielded 4,144 offspring in 11 weeks, and spawned 12 times. The eggs hatch in  $4\frac{1}{2}$  to 6 days. The older fish in a pond should be used for bait when they have spawned, as they die soon after.

This minnow is a popular bait for panfish in Minnesota. It has been used for pike fishing when larger species are not available. After the early

spring seining of "shiner" minnows, the fat-headed minnow is probably the most easily obtainable bait fish in the State. The fat-headed minnow grows well in small ponds in Minnesota and is ideal for propagation. More than 200,000 fish (328 pounds) to an acre have been raised in other States. The fat-headed minnow feeds mainly on microscopic plant food but will take animal plankton and insects.



*Blunt-nosed minnow*

### Blunt-nosed minnow

*Hyborhynchus notatus* (Rafinesque)

*General description.*—First obvious ray of the dorsal fin thickened, standing out from following rays; scales small and crowded behind the head; mouth small, horizontal, and under the snout; back flat and straight; lateral line complete from head to tail; breeding male with a tiny blister-like swelling of skin at each corner of mouth, tubercles on snout only; spot at base of tail dark but diffuse; body cavity lined with black; intestine less than twice body length.

This minnow resembles the fat-headed minnow in appearance, breeding habits, and distribution. It is more abundant than the fat-headed minnow in the large, clearer lakes and firm-bottomed streams. In Michigan, the bluntnose has been called the most common minnow in inland waters. It is important as a food for game fish because of its preference for large lakes where game fish are abundant. The males grow larger than the females, attaining a maximum length of 4 inches. Spawning begins the latter part of May and continues through August in Michigan but may begin 1 month earlier in western Minnesota. Water temperatures of 70° F. or higher are necessary before spawning takes place. A female may spawn at least twice in one season, and eggs

are laid under any flat object on the bottom in water as deep as 8 feet. A depth of 6 inches to 3 feet is preferred. A count of eggs in 10 females averaged 2,005 per fish. The eggs hatch in 7 to 15 days. The young reach marketable size by fall and spawn the following spring.

Maximum age is about 4 years. The blunt-nosed minnow has been propagated in Michigan at the rate of 104,800 fish (250 pounds) an acre. In general, this species seems less prolific than the fat-headed minnow, but in Ohio 473,350 an acre have been raised. This species will not withstand crowding in minnow containers so well as the fat-headed minnow.

Because good keys for the separation of minnow species were not available until recent years, much of the literature and the records of stomach contents for the blunt-nosed minnow have probably been confused with those of the fat-headed minnow. More recent studies indicate that the feeding habits of both these species are similar; so the records, general as they are, could apply to either species.

The blunt-nosed minnow is known to eat diatoms, algae, aquatic insects, entomostracans, fish eggs, fish fry, and oligochaete worms. Occasionally this minnow will eat its young. Some stomachs of the blunt-nosed minnow contain only plant plankton; others, only surface drift; and others, large percentages of insects, higher plants, animal plankton, debris, or silt. A summary of food studies by several workers shows that, in general, the food percentages are: insects, 15.9; crustaceans, 3.5; entomostracans, 2.0; surface drift, 10.7; annelids, 0.5; animal plankton, 6.9; plant plankton, 35.0; plants, 8.7; algae and diatoms, 4.9; and silt and debris, 11.8.

### Central stone-roller

*Campostoma anomalum pullum* (Agassiz)

*General description.*—Plump, sturdy minnow, under-slung suckerlike mouth with horny ridge forming the lower lip; scales large, sometimes flecked with black pigment; black crescent on dorsal fin of adults; large tubercles on top of head of breeding males; lining of abdominal cavity black, intestine very long and wound spirally around air bladder.





*Central stone-roller*

The stone-roller is a minnow of creeks and small rivers and prefers rocky, shady streams with swift water. It is common in south Michigan, Minnesota, and Wisconsin but is found from the St. Lawrence to Mexico, excluding the southeastern part of the United States.

This fish spawns from May to June 15. Great numbers ascend streams, where the males excavate funnel-shaped cavities several inches deep and guard these and the eggs for a short time. The stone-roller minnow reaches maturity during its second or third summer. The males attain a size of 6 inches and the females less than 5. This fish is regarded as one of the best baits for bass. It is tenacious of life, and it is brightly colored during the breeding season.

The stone-roller minnow is chiefly a bottom feeder. It has been known to eat algae, diatoms, small amounts of animal plankton, a few aquatic insects, and plant tissue. Sand and clay are often found in the intestinal tract but are probably taken along with the various foods. A study of 20 specimens from the Oswego River system (New York) showed food percentages as follows: midge larvae, 10.0; diatoms, 50.0; algae, 10.0; and sand and silt, 30.0.

### Common sucker

*Catostomus c. commersonii* (Lacepede)

*General description.*—Sucking mouth with thick fleshy lips on under side of head; fine scales near head and coarse ones on tail; small specimens have three large dark blotches on each side of body; more than 10 rays in dorsal fin (true, native minnows have less than 10); no spiny rays in any of the fins.

This fish is widely distributed in the United States, occurring east of the Great Plains from Canada to Georgia. It thrives under a variety of conditions but prefers clear water in lakes and streams.

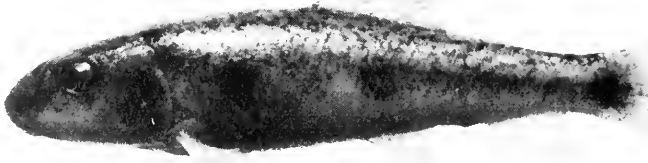
*Common sucker*

The common sucker runs upstream to spawn early in the spring. It prefers swift water and gravel bottoms, scattering its eggs freely in the current. The sucker will spawn to some extent in lakes if there are no outlets and inlets. Work done in New York indicates that temperatures from 57° to 68° F. are best for hatching eggs. The incubation period is then 5 to 7 days. At 70° F. mortality is high and the incubation period is 4 days. At 40° F. none hatched in more than 14 days. As many as 47,800 eggs were taken from one female.

The common sucker has diversified feeding habits. It seems to feed on any food that may appear in the water, including fish and fish eggs. It is largely an animal feeder in Lake Nipigon. This species is sometimes divided into size-groups upon the basis of diet, as follows: (1) Rotifer-eating stage, at a length of 0.7 inch; (2) cladocera-eating stage, at a length of 1.2 inches; (3) insectivorous stage, more than 2 inches in length. The common sucker has been known to feed on mud, plants, mollusks, insects, entomostracans, diatoms, desmids, rotifers, crustaceans, and protozoans. Stomach analyses showed 100 percent insects in some collections, 100 percent higher plants in others, 95 percent mollusks in one collection, and 50 percent drift in other stomachs examined. The average percentages of various food items found in stomachs examined by several workers are as follows: insects, 39.0; crustaceans, 3.3; mollusks, 10.3; surface drift, 2.1; plankton, 26.3; higher plants, 9.7; miscellaneous, 8.8; and bryozoans, 0.5.

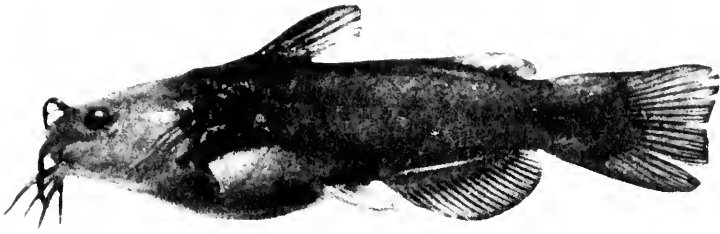

*Northern black bullhead*

**Northern black bullhead**

*Ameiurus melas melas* (Rafinesque)

*General description.*—No scales on body; eight large barbels around mouth, the four under the chin gray or black; anal fin with 18-20 rays; adipose fin (small fleshy fin on back behind dorsal fin) distinct and free; fin membranes jet black, rays lighter in color; body, dark-brown to black above, yellow to dirty gray on belly.

This common bullhead is found from New York and the Missouri basin south to Texas and Alabama. The fish is small, and the young are often used for bait along the Mississippi River.

The black bullhead spawns from April to June. The nest is usually 6 inches deep on shallow sand or mud bottom. The eggs and young are guarded by both parents.

The food of this species includes aquatic vegetation, fish, small mollusks, snails, crayfishes, and aquatic insects. Vegetation, aquatic insects, and small mollusks are the preferred items.

*Stone catfish***Stone catfish***Noturus flavus* (Rafinesque)

*General description.*—No scales on body; eight barbels (whiskers) around mouth, the four under the chin usually white or yellowish; anal fin with 14–16 rays; adipose fin low, grown to back; fin membranes light in color, rim of caudal and adipose fins often creamy yellow; body, olive to yellowish green on back and sides, belly lighter.

The stone catfish is usually found under stones in swift creeks and small rivers east of the Rockies from Canada south to Virginia and Texas. This species grows to a length of 12 inches.

The eggs are laid in depressions under boards and rocks during June and July. The nest is watched by the adult. The young remain in the nest for some time after hatching.

Little is known of the feeding habits, but in southern Minnesota this fish is believed to subsist mainly on aquatic insect larvae and earthworms.

**Western mud minnow***Umbra limi* (Kirtland)

*General description.*—Tail fin rounded; dorsal fin far back on body with about 12 rays; dark vertical bar at base of tail; scales on head (no other fish described in this section possesses scales there).

This species is distributed through the Great Lakes region and the central basin of the continent, extending as far southwest as Arkansas. It prefers spring-fed, soft-bottomed pools and is common in boggy or stagnant places. This fish is not a true minnow but is related to the northern pike. It grows to a length of 5 inches.



*Western mud minnow*

Spawning takes place in early spring, usually upstream in small brooks. The mud minnow is very hardy but is not a popular bait species, except in Wisconsin, as it is not very active.

This species hibernates in the mud and will go down 4 to 9 inches. It may be found in the mud in a horizontal position or in a vertical position with the head upward. When alarmed, it usually buries itself.

Evermann (1901) says: "So persistently do they cling to life that it is really difficult to kill them. ... Its unexcelled tenacity of life is, however, about the only thing it has to recommend it as a bait minnow. Its somber, unattractive color prevents it being readily seen by game fishes, and its tendency to pull down or get to the bottom also militates against it. But bass and pickerel and pike do sometimes take it and, in spite of its deficiencies, the Mudfish is a good thing to have in one's minnow pail."

The food of the mud minnow is mostly of an animal nature. It has been known to eat insects, spiders, mites, amphipods, entomostracans, snails, leeches, oligochaete worms, nematodes, rotifers, protozoans, plants, algae, and earthworms. A summary of the records indicates that mud minnows will take as much as 80 percent of their food from insect fauna, some have taken 90 percent amphipods, others have taken 50 percent entomostracans. More than 20 percent of the stomach contents of others has been plant food. More than 50 percent of the food of some stomachs has been mollusks, and in one collection 40 percent of the stomach contents was surface drift.

Stomach analyses by various workers showed that the digestive tracts of mud minnows contained the following average percentages: insects, 45.6; amphipods, 11.1; entomostracans, 16.3; mollusks, 12.3; arachnids, 0.16; plants, 7.1; surface drift, 4.6; algae, 1.4; miscellaneous, 1.24; and silt, 0.2.

## BIBLIOGRAPHY

COOPER, GERALD P.

1935. Some results of the forage fish investigations in Michigan. Trans. Amer. Fish. Soc. 65: 132-142.

-----

1936. Age, growth, and suitability for propagation of the golden shiner (*Notemigonus crysoleucas auratus*). Mich. Acad. Sci. Arts and Letters, 21: 587-597.

EVERMANN, B. W.

1901. Bait minnows. 6th Ann. Rept. of N. Y. Forest, Fish and Game Comm., pp. 307-356.

FISH, F. F.

1938. Treat—think—and be wary, for tomorrow they may die. Prog. Fish Cult. 39: 1-9.

HASLER, A. D.; THOMSEN, H. P.; and NEISS, JOHN.

1946. Facts and comments on raising two common bait minnows. Wis. Cons. Dept. Bull. No. 210, 14 pp.

HUBBS, CARL L., and COOPER, GERALD P.

1936. Minnows of Michigan. Cranbrook Institute of Science, Bull. No. 8, 95 pp., illus.

KLAK, GEORGE E.

1940. *Neascus* infestation of black-head, blunt-nosed, and other forage minnows. Trans. Amer. Fish. Soc. 69 (1939); 273-278.

LANGLOIS, T. H.

1937. Bait culturists guide. Ohio Dept. of Agr. Bull. 137, 18 pp., 4 fig.

-----

1941. Observations on bait culture. Ohio Conserv. Bull., Aug. 1941, pp. 18-19.

MARKUS, HENRY C.

1934. Life history of the blackhead minnow (*Pimephales promelas*). Copeia 1934 (3) 116-122.

-----

1939. Propagation of bait and forage fish. U. S. Dept. Com. Fish. Circ. 28, 19 pp., 10 fig.

MEEHEAN, O. LLOYD.

1934. The role of fertilizers in pondfish production. Trans. Amer. Fish. Soc., 64: 151-154.

-----

1937. Control of predaceous insects and larvae in ponds. Dept. of Int., Fish and Wildlife Service, Prog. Fish Cult. 33: 15-16

RANEY, E. C.

1940. The breeding behavior of the common shiner, *Notropis cornutus* (Mitchill). *Zoologica* 25 (Part 1): 1-14, 4 pl.

- 1941. Pond propagation of the silvery minnow, *Hybognathus regius*, Girard. Dept. of Int., Fish and Wildlife Service, Prog. Fish Cult. 55: 43-44.

SPOOR, WILLIAM A.

1938. Age and growth of the sucker, *Catostomus commersonnii* (Lacepede), in Muskellunge Lake, Vilas County, Wisconsin. *Trans. Wisc. Acad. Sci., Arts and Letters*, 31: 457-505.

STEWART, NORMAN H.

1926. Development, growth, and food habits of the white sucker, *Catostomus commersonnii*, LeSueur. *Bull. U. S. Bur. of Fish.*, 42 147-184, Doc. 1007.

SURBER, THADDEUS.

1940. Propagation of minnows. *Minn. Dept. Cons. Bull.* 22 pp.

VAN CLEAVE, H. J., and MARKUS, HENRY C.

1929. Studies on the life history of the blunt-nosed minnow. *Amer. Nat.* 63: 530-539.

VIOSCA, PERCY, Jr.

1937. Pondfish culture. Pelican Pub. Co., New Orleans, La. 260 pp.

WASHBURN, G. N.

- Propagation of the creek chub in ponds with artificial raceways. *Trans. Amer. Fish. Soc.* 1946 (In press).

WYNNE-EDWARDS, V. C.

1933. The breeding habits of the black-headed minnow, *Pimephales promelas* (Rafinesque). *Trans. Amer. Fish. Soc.*, 62 (1932): 382-383.









MBL WHOI Library - Serials



5 WHSE 00076

